

# Paper Electronics: Circuits on Paper for Learning and Self-Expression

Jie Qi  
B.Sc. Mechanical Engineering  
*Columbia University*  
S.M. Media Arts and Sciences  
*Massachusetts Institute of Technology*

Submitted to the Program in Media Arts and Sciences  
School of Architecture and Planning  
In partial fulfillment of the requirements for the degree of  
*Doctor of Philosophy in Media Arts and Sciences* at the  
*Massachusetts Institute of Technology*  
September 2016



This work is licensed under the Creative Commons Attribution 3.0 License.

The author hereby grants to MIT permission to reproduce and to distribute publicly paper and electronic copies of this thesis document in whole or in part in any medium now known or hereafter created.

## **AUTHOR**

---

Jie Qi  
Program in Media Arts and Sciences  
August 17, 2016

## **CERTIFIED BY**

---

Joseph A. Paradiso  
Alexander W Dreyfoos (1954) Professor  
Program in Media Arts and Sciences  
Thesis Supervisor

## **ACCEPTED BY**

---

Patricia Maes  
Academic Head  
Program in Media Arts and Sciences





# Paper Electronics: Circuits on Paper for Learning and Self-Expression

Jie Qi

Submitted to the Program in Media Arts and Sciences, School of Architecture and Planning, on August 17, in partial fulfillment of the requirements for the degree of Doctor of Philosophy in Media Arts and Sciences.

## **ABSTRACT**

In this dissertation, I explore the theme of wonder in technology, learning and self-expression through the lens of paper electronics, which is circuit building on paper using conductive tapes and circuit components as electronic craft materials. This new medium blends the interactive functionality of electronics with the expressive flexibility of the paper medium. I present an overview of the paper electronics medium as well as its extension in the form of electrified books, books with circuitry integrated with its pages and spine. I then described the design of a paper electronics toolkit called circuit stickers and how this toolkit was deployed through a company called Chibitronics. Finally, through the circuit stickers toolkit, I investigate and evaluate the paper electronics medium as a learning tool and approach, expressive medium and method to engage more diverse communities in technology creation.

These investigations show that paper electronics has indeed impacted learners, educators and creators across many backgrounds and disciplines. It has enabled educators to teach a broad range of subjects and skills in new ways. Artists have used paper electronics to explore electricity and interactivity for self-expression, demonstrating the aesthetic flexibility and expressive potency of this medium. Finally, it has engaged creators from diverse communities and backgrounds including educators, Makers, and crafters. It enables not only new approaches to learning and creating technology, it also engages new types of creators in inventing surprising technological artifacts—ones that inspire new experiences, objects and opportunities for wonder.

## **THESIS SUPERVISOR**

Joseph A. Paradiso

Alexander W Dreyfoos (1954) Professor  
Program in Media Arts and Sciences



# Paper Electronics: Circuits on Paper for Learning and Self-Expression

Jie Qi

**THESIS READER**

---

Leah Buechley  
Associate Professor of Media Arts and Sciences (2009 – 2014)  
Massachusetts Institute of Technology



# Paper Electronics: Circuits on Paper for Learning and Self-Expression

Jie Qi

**THESIS READER**

---

Edith Ackermann  
Visiting Scientist in Media Arts and Sciences  
Massachusetts Institute of Technology  
Senior Research Associate  
Harvard Graduate School of Design



# ACKNOWLEDGEMENTS

Thank you to my advisors. To Leah Buechley, for inviting me on the journey that is High-Low Tech, for creating and nurturing a space both physically and in my mind that made all this work possible. To Joe Paradiso, for welcoming me into Responsive Environments and giving me the support, resources, confidence and freedom to pursue my wild research explorations. To Edith Ackermann, for helping me wander and play through these ideas with humor, imagination and poetry. To Mitch Resnick, for inviting me to continue my work in Lifelong Kindergarten and for your unending dedication to nurturing learning and creativity.

Thank you to the members of High-Low Tech and Responsive Environments for your friendship, encouragement, inspiration and collaboration over these six years: Jennifer Jacobs, David Mellis, Emily Lovell, Hannah Perner-Wilson, Sam Jacoby, Ed Baafi, Sonja de Boer, Kanjun Qiu, Katia Vega, Artem Dementyev, Gershon Dublon, Nan Zhao, Brian Mayton, Spencer Russell, Donald Derek Haddad, Juliana Cherston, David Ramsay, Asaph Azaria, Mark Feldmeier, Nan-Wei Gong. And to the many others that have made the Media Lab such a special place play: Tiffany Tseng, Ricarose Roque, Sayamindu Dasgupta, Rebecca Kleinberger, Akito Van Troyer, Arthur Petron, Xiao Xiao, Cindy Kao, Xin Liu, Akshay Mohan, Ivan Sysoev, Dan Chen, Edwina Portocarrero, Lining Yao, Jin Joo Lee, Nadya Peek, David Cranor, Arlene Ducao, Natalie Freed, and so many more.

Thank you to the Media Lab for making all of this possible. To Joi Ito for your openness and support of my unusual research trajectory. To Kevin Slavin, Ethan Zuckerman and the rest of the Media Lab faculty for your thoughtful guidance and inspiration. To Linda Peterson, Keira Horowitz, Analisha Centeno, Tom Lutz, Joost Bonsen, Stacie Slotnick, Alexandra Kahn, Jess Sousa and all the others that keep this place going. To David Nino, Eric von Hippel, Gretchen Henderson, Erik Demaine and the rest of the MIT Community for your support and making this such a special place to grow.

Thank you to the amazing individuals that make Chibitronics possible. To bunnie, for your friendship, mentorship and collaboration all along this crazy journey. To Patricia Ng, for your patience and juggling all the parts that keep Chibitronics alive and evolving. To the growing Chibitronics family, Pauline Lim, Sean Cross, Ingrid Cheung, Christina Hsu, Alisha Panjwani, Lindsay Balfour and many others for your creativity and inspiring contributions. To Josh Lifton and Eric Strom at Crowdsupply and Christina Xu for helping us launch our idea years ago, to our backers that gave us the funding and support

to make this possible, and the team at AQS—Gavin Zhao, Queenie Gu, Celia Wang, Zoey Wang and many others—who helped us turn our ideas into physical reality.

Thank you to my amazing collaborators. To David Cole, Jennifer Dick, Paul Oh and many others from Nexmap, the National Writing Project for growing 21<sup>st</sup> Century Notebooking into the community it has become. To Susan Klimzac, Molly Adams, Lou Buran, Josh Burkner, Colleen Graves, Nicole Fuerst, Jeannine Huffman, Jill Dawson, Kevin Hodgson, David Peins, Corinne Okada, Fay Shaw and all the educators out there teaching your students to be lifelong learners and creators. To Mary Uthuppuru, Yael Friedman, Sarah Mallory, K-Fai Steele, Owen Trueblood, Becca Rose and all the artists who have contributed your personal visions. To Yoshihiro Kawahara, Steve Hodges and Tungshen Chew for your technical guidance and inspiration. To my amazing team of interns—Asli Demir, Paelle Powell, Selam Gano, Lindsay Epstein and Adrian Melia—who have contributed to this work in so many ways.

Thank you to Sally Rosenthal, for your unending cheer and clarity. To Akiba, Jacinta Plucinski and Joe Moross for your kindness, generosity and perspective.

Finally, never ending thanks to my family—Mom, Dad, Meimei and Longlong—and to Ira Winder, for your love and understanding, for giving me strength and peace.



# Contents

## Chapter 1

- 13 **INTRODUCTION**
- 14 What is paper electronics?
- 16 Chapter summaries

## Chapter 2

- 18 **BACKGROUND**
- 18 Do-It-Yourself electronics
- 21 Circuit craft
- 24 Flat, flexible & printed circuits on paper

## Chapter 3

- 29 **PAPER ELECTRONICS**
- 29 Electrified books
- 36 Circuit stickers
- 38 Chibitronics

## Chapter 4

- 48 **EDUCATION**
- 49 Conversations with educators
- 52 How are educators using paper electronics?
- 64 What educators have to say
- 84 Reflections and lessons learned

## Chapter 5

- 89 **EXPRESSION**
- 91 Paper Curiosities exhibition
- 92 Materials analysis
- 98 Diversity in approach
- 105 Expressive flexibility
- 107 Discussion

## Chapter 6

- 112 **COMMUNITY**
- 113 Who is participating?
- 120 What are they creating?
- 127 Changing the technology narrative

## Chapter 7

- 130 **FUTURE: PAPER PROGRAMMING**
- 130 Code collage: programming with circuit stickers
- 137 Code clip: reusable, programmable microcontroller for paper

145 **CONCLUSION**

149 **REFERENCES**

157 **APPENDIX A: PAPER CURIOSITIES**

157 Paper Curiosities: artist case studies

206 Paper Curiosities: extended exhibition

211 **APPENDIX B: MODULAR PROGRAMMING**

# 1. Introduction

In *The Enchantment of Modern Life*, Jane Bennett defines wonder:

To be struck and shaken by the extraordinary that lives amid the familiar and everyday.

Wonder is a 'moment of pure presence' where thoughts and limbs are brought to rest, even as the senses continue to operate, indeed, in high gear. You notice new colors, discern details previously ignored and hear extraordinary sounds, as familiar landscapes of sense sharpen and intensify. The world comes alive as you are simultaneously transfixed in wonder and transported by sense, both caught up and carried away.

The surprise of wonder brings both pleasure from being charmed by the new and singular, and disorientation from being knocked out of the routine. The overall effect is a mood of fullness, plenitude, or liveliness, a sense of having had one's nerves or circulation or concentration powers tuned up and recharged. Like a shot in the arm, wonder brings a fleeting return to childlike excitement about life.

The experience imbues the ordinary world around us with a sense of magical possibility that was not there before. It is why when technology is seamlessly integrated into the commonplace, it can evoke a sense of wonder. It is this feeling of wonder that fuels our curiosity, enticing us to explore new worlds, engage in learning and invent new experiences (Bennett, 2001).

However, wonder is more than just surprise. If the new and unexpected are perceived to be threatening, generally we experience fear. Instead of heightening our senses, fear shuts down our perception as we try to push back the perceived threat and run away to safety. Once the novel is confirmed to be non-threatening, our curiosity gets unlocked leading us to welcome and try to understand these new encounters. If our attempts to explain fail repeatedly, rather than being frustrated we generally dismiss the new and unusual as uninteresting and move on (Fisher, 1998). This is with the exception of those spirits who purposely find thrill in the dangerous or use the unexpected, without the urge to debug or explain, as an opportunity to further their musings (Ackermann, 2015). Therefore, to nurture experiences of wonder, we must simultaneously present the new and surprising but also in a way that is not threatening and can be understood.

Likewise, technology is often a foreign entity that is boxed away from the user, due to their fragility and potential hazard. However, by presenting technology through familiar means or unexpected media, like craft materials, perhaps we can nurture a sense of wonder and dispel the fear often associated with making or understanding computational devices. Through encouraging individuals to not just investigate but also create technology, in contexts that matter, we empower them to use their understanding to create new experiences for themselves and others, new experiences that were not possible before, and inspire new opportunities for wonder. It is this goal that guides my own research in paper electronics.

### **WHAT IS PAPER ELECTRONICS?**

I explore the theme of wonder in technology, learning and self-expression through the lens of *Paper electronics*—also called *paper circuitry*— that is, making circuitry on paper substrates using craft materials and techniques. It uses conductive materials like copper foil tapes, silver inks and graphite paints along with small flat electronics components that are easily integrated into paper. As a medium, paper electronics blends the interactive functionality of electronics with the expressive flexibility and familiarity of the paper.

I focus on using a limited set of tools and materials that have the most flexible and electronically functional properties—namely copper tape as the connector, soldering for making permanent connections, surface mount or flattened electronic components and Arduino-based microcontrollers for adding computation. The basic tools, materials and techniques are described in further detail in my master’s thesis (Qi, 2012). My hope is for learners and creators to easily learn how to physically manipulate the materials and quickly move on to the heart of the activity, which is exploring and learning the electronics and applying it to create personalized projects.

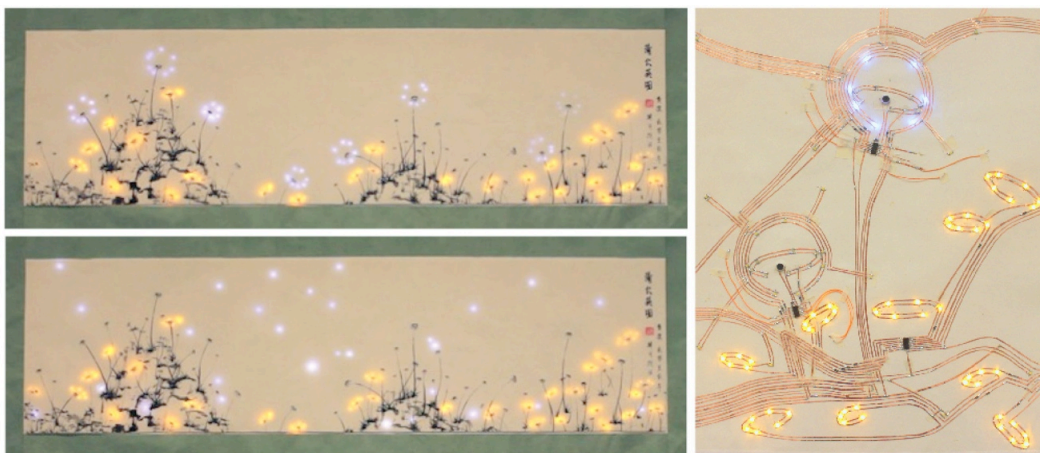

**Figure 1.1. Dandelion Painting with seeds dispersing (left) and copper tape circuitry beneath (right).**

*Pu Gong Ying Tu (Dandelion Painting)* shown in Figure 1.1 is an example of what a paper electronics project might look like. This is an interactive painting of a dandelion field where seeds disperse and trigger new flowers when viewers blow on the dandelion flowers. Sensors, programmed microcontrollers and LEDs beneath the painting are what bring the painting to life, creating “animated paint strokes” using the programmed lights. The circuitry beneath the painting, created with copper tape, also follows the lines of the landscape painting and shows how the physical materials of electronics can also be expressive. This piece blends traditional Chinese ink painting with interactive, off-the-shelf electronics, bringing surprising interactions to the normally inert painting medium. This, in combination with the familiar, delightful experience of blowing on dandelion flowers, was designed to evoke an experience of wonder for those interacting with it.

The story behind this painting is also an example of how paper electronics can appeal to creators of broad interests and how bringing in such diverse perspectives result in new technologies. The *Dandelion Painting* is based on a poster of a dandelion titled *When is a Weed not a Flower?* created during a workshop on sensors by participants Jessie Thompson and Zachory Berta (Figure 1.2). Jessie came from a plant biology perspective and created plant-themed projects for her paper electronics. Upon trying the microphone, which could detect the sound of wind blowing, she came up with the idea to use the interaction for a dandelion flower. Since this piece, many other creators around the world have created their own interactive dandelion flowers in the form of paintings, murals and even e-textile circuitry.



**Figure 1.2. *When is a Weed not a Flower?* by Zachory Berta and Jessie Thompson**

As with technology in general, paper electronics does not need to be complex to be meaningful and engaging. For example, the left of Figure 1.3 shows a simple circuit with two red LEDs and a DIY pressure sensor. The harder one presses on the sensor, the brighter the LEDs glow. By adding a simple illustration of a puppy on top, this circuit turns into a character that blushes when you give it some love by pressing on its heart (Figure 1.3, center and right). This artifact shows how the narrative context breathes life and adds an entirely new dimension of meaning into the abstract circuit, how important

it is to support both the expressive imagination as well as technical functionality as we design new ways to build technologies.



Figure 1.3. Blushing puppy card made with red LEDs and DIY pressure sensor.

This brings me to ask: When we engage individuals in sharing their voices—bringing in their own unique perspectives and imaginations—through building technology, a medium that was once open only to “trained experts,” what might they say? What new stories will be told and artifacts will be made? What might we learn about ourselves and our relationships to technology? And how do we engage those audiences? The remainder of this dissertation begins to explore these questions.

This is a continuation of my master’s thesis work, in which I developed the initial tools, materials and techniques for the paper electronics medium and shared these in preliminary workshops. For my doctoral research, I’ve continued by exploring paper electronics integrated with book structures and developed a custom toolkit called circuit stickers. Through starting a company *Chibitronics PTE*, my cofounders and I have made the circuit stickers toolkit publicly available as a product to individuals, educators, students and creators around the world. The remainder of my work looks at how people can use the paper electronics medium as a learning and teaching tool, as an expressive medium and as a way to engage more diverse communities in technology creation.

## CHAPTER SUMMARIES

In *Chapter 1: Introduction*, I introduce wonder through creating technology with paper as the personal basis for this research. Then I define the paper electronics medium.

In *Chapter 2: Background*, I share an overview of background and related work in do-it-yourself electronics, approaches that blend electronics with craft, research specifically in paper-based electronics and how these techniques are being made more accessible through new toolkits.

In *Chapter 3: Paper Electronics*, I review my own design contributions to the paper electronics medium. I summarize my experiments in developing electrified books, physical books that have circuitry on its pages or in the spine. Then I describe the design and evolution of the circuit stickers toolkit and supporting educational resources. Finally, I share how we deployed circuit stickers into the wild as a product through Chibitronics. In *Chapter 4: Education*, I investigate what educators are doing with paper electronics to evaluate this medium as a learning and teaching tool. I describe my method of interviewing 20 educators who have extensively used paper electronics in their practice and examining their documentation online and in print media. I share what educators and students have done, their reflections based on the interviews, and analyze what does and does not work for educators as they use paper electronics to teach.

In *Chapter 5: Expression*, I evaluate paper electronics as an expressive medium. I share my approach of commissioning artists to create art pieces that blend the circuit stickers toolkit and their own existing creative practice and conducting interviews and surveys to learn about their creative process and experience with the medium. Insights from these interviews, surveys as well as through examinations of the piece are presented in the second part of the chapter.

In *Chapter 6: Community*, I present an overview of which communities are creating with paper electronics, using Chibitronics users as a representative sample of the larger community. I share my approach of analyzing sales data as well as an examination of websites that link to Chibitronics.com to get a sense of demographics as well as which sub-communities are participating. The remainder of the chapter describes the main sub-communities of users—educators, Makers and crafters—through what they created, how they documented and discuss the unique values and needs of each. I then reflect on what their participation may mean for technology in general.

In *Chapter 7: Future: Paper Programming*, I present my current and future investigations for paper electronics toolkits. My first investigation is a set of modular stickers that enable coding through physical connections and tinkering. The second investigation is a programmable clip and circuit viewer that enables learners to learn coding through computational notebooks that blend code with physical circuitry on the page.

In *Chapter 8: Conclusion*, I share a summary of lessons learned from this research along with insights on which properties of paper electronics makes it a suitable learning tool, expressive medium and method for engaging broader participation in technology creation.

## 2. Background

My explorations in paper electronics are part of a rich ecosystem of existing and emerging resources for technology creators. This chapter shares some of the social, technical and research contexts that inform and inspire this work.

I start with a brief overview of do-it-yourself electronics cultures from early ham radio enthusiasts to the modern Maker Movement. Next I describe contemporary approaches to engage broader audiences in building technology through nontraditional materials and tools, focusing particularly on electronics and craft. Finally I give a review of the current state of paper-based electronics research in materials science, electrical engineering and human-computer interaction.

### **DO-IT-YOURSELF ELECTRONICS**

Building electronics at home has been a popular past time since at least the early 20<sup>th</sup> century. It was at this time that radio became widely available through mass production, which launched the amateur radio community. Many individuals in the community enjoyed building their own radios, often from kits of incomplete parts and limited instructions, rather than purchasing pre-assembled products (Haring, 2007). Another popular early electronics construction kit is the Erector Set. First released in 1911, this kit of mechanical components was the first to include an electric motor so that young creators could build self-actuated models (Martinez and Stager, 2013). After World War II, electronic kits became even more popular. The most common was Heathkits, introduced in 1947, which offered complete kits of parts and instructions that enabled hobbyists to make functioning electronic equipment like radios and televisions without an engineering background (Fisher, 1992).

In addition to kits, early electronics enthusiasts could also find their own supplies and follow inspiration and instructions in popular periodicals and books. Periodicals included *Popular Mechanics*, which began in 1902; *Radio-Craft* (later renamed *Radio Electronics*), which began in 1929; and *Popular Electronics*, first published in 1954. Classic books include *Fun with Electricity* by A. Frederick Collins (1936), *The Boy's First Book of Radio and Electronics* by Alfred Morgan (1954) and *Introduction to Electronics* by Forrest A. Mims (1972). These books provided both practical overviews of electronics theory as well as instructions on how to build working systems and experiments.



With the introduction of more advanced electronics, especially the personal computer in the 1980's, hobbyist electronics began to decline as creators shifted their attention from creating physical systems to creating systems in software (Fisher, 1992). However, today we see a revival in hobby electronics through the emerging Maker Movement, which promotes a hands-on and inventive approach to building a broad range of physical technologies—both creating the technology itself such as home-made robotics as well as using new forms of digital fabrication technologies like 3D printing or laser cutting (Anderson, 2012). This movement began with the publication of *Make Magazine* in 2005 and grew with subsequent physical gatherings of the community called Maker Faires starting in 2006. These events now take place in over 135 locations worldwide including at the White House in 2014 (Maker Media, 2015 and White House, 2016).

More electronics kits have also sprung up to help beginners and hobbyists create their own electronics. Unlike the product-focused kits described earlier, these kits often can be put together in different combinations to produce a variety projects. For instance the classic Science Fair Electronic Project Kit<sup>1</sup> has electronic components mounted to a board with exposed springs as terminals. This enabled learners to build circuits by inserting wires between springs to connect components. Other kits put electronic components into easy-to-manipulate blocks enclosures that snap together with custom magnetic connectors, like the early Braun Lectron System<sup>2</sup> and modern Snap Circuits<sup>3</sup>. Both show circuit schematic symbols on the blocks to help learners associate circuit components with their written symbol. With the decreasing cost of electronics manufacturing, more recent modular electronics toolkits like littleBits and LightUp embed more complex circuitry into each module, like adding computational capability (Bdeir & Ullrich, 2009 and Chan et al., 2013). Images of these kits are shown below in Figure 2.1.



**Figure 2.1. From left to right: 160-in-one Science Fair Electronic Project kit with springs as connectors (image by mightyohm); Braun Lectron System, Snap Circuits (image by Adafruit), littleBits (image by Sparkfun Electronics) and LightUp (image from lightup.io<sup>4</sup>) with magnets as connectors.**

---

<sup>1</sup> Lawton, C. (2102). “Ten Classic Electronic Toys and Their Modern Equivalents (GeekDad Wayback Machine)” <http://www.wired.com/2012/05/ten-classic-electronic-toys/>

<sup>2</sup> Carlson, E. (1967). “Electronic Dominoes: the Fun Way to Learn Electronics!” *Electronics Illustrated*. <http://ww.decodesystems.com/lectron.html>

<sup>3</sup> Snap Circuits. (2016). <http://www.snapcircuits.net/>

<sup>4</sup> LightUp. (2016). <http://www.lightup.io/>

Modern electronics construction kits show a growing focus on teaching learners to program the circuits they build (Figure 2.2). For example Lego Mindstorms and PicoCricket are modular electronics toolkits that enable learners to upload programs from computers onto their electronic constructions (Resnick et al., 1998). The Makey Makey<sup>5</sup> board allows creators to build custom keyboard interfaces out of objects found in the environment by clipping to them, which then become physical inputs for screen-based programs.



Figure 2.2. Lego Mindstorms example robot, image by Eirik Refsdal (left); Picocricket modules, image by Jean Baptist Lebrune (center); Makey Makey, image by Danny Nicholson (right)

Especially associated with the Maker Movement is the Arduino<sup>6</sup> board, an open source programmable microcontroller board designed to simplify hardware programming for hobbyists and designers. While not actually a physical construction toolkit—the Arduino is a circuit board and users construct the circuitry around it with standard electronic components—it simplifies the programming process through a custom open source programming language and interface, acting as a toolkit for software. Since its launch in 2005, this board has inspired a variety of other programmable boards and software extensions as well as a growing community of hobbyist users and contributors.

Even though all of these resources have made electronics building more accessible, hobby electronics communities have been male-dominated from the very beginning. Ever since it originated, the amateur radio community has been majority male and promoted a culture of masculine identity and likewise Heathkit users were approximately 95% male based on sales data (Haring, 2007 and Fisher, 1992). Erector sets were marketed specifically toward boys and pitched to parents that it would reduce “problems with boys” (Martinez and Stager, 2013). Titles of publications, like *The Boy’s* book series to electronics and radio by Alfred Morgan, even say so in the name.

---

<sup>5</sup> MakeyMakey. (2016). <http://makeymakey.com/>

<sup>6</sup> Arduino. (2016). <https://www.arduino.cc/>

Today, the Maker Movement also struggles with gender balance, with 81% of its readership and 70% of World Maker Faire attendees being male in 2012. Other forms of diversity also have remained an issue. For example the average Heath kit customer had at least one college degree (Fisher, 1992) and 97% of Make magazine readers and Make Faire attendees have gone to or graduated from college (Maker Media, 2015). Make magazine also rarely feature Makers who are women and/or underrepresented minorities (Buechley, 2013).

In an effort to both engage broader audiences in creating technologies, as well as to diversify the types of technological artifacts that are produced, researchers like myself are now looking at new material and methods to create technologies and developing tools and toolkits based on these techniques. The following section looks at this approach, focusing specifically on technology and craft.

## **CIRCUIT CRAFT**

Hobbyists and professionals alike often start prototyping circuitry by hand, using tools like breadboards and protoboards. The breadboard provides a press-fit grid for quick connections and disconnections for testing circuits (Figure 2.3, left) while protoboards are a more permanent solution in which components are soldered to a board precut with a grid of holes (Figure 2.3, center). Once the circuit is designed with these tools, creators often move on to designing a printed circuit board (PCB) with computer aided design (CAD) software (Figure 2.3, right). PCBs are produced by etching the design into a copper plate or sending the CAD file off to be manufactured by a professional board house. For certain radio frequency and high-performance circuitry, the mechanical connections and geometric limitations of breadboards and protoboards fail, so these are often prototyped through CAD and simulations and then translated directly into PCBs.

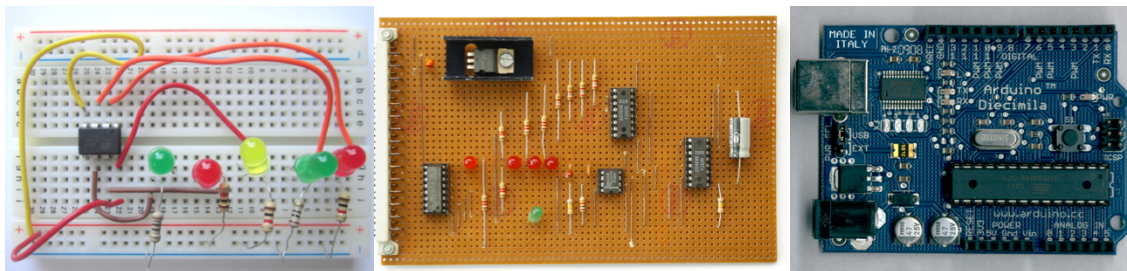
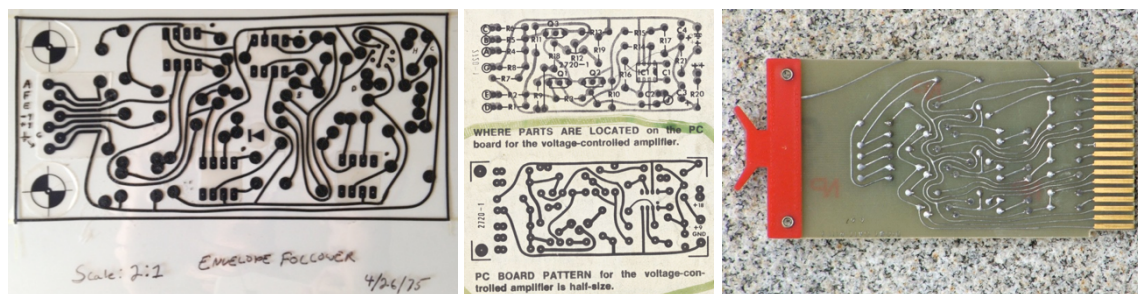

**Figure 2.3.** From left to right: breadboard circuit, protoboard circuit (image by smial) and printed circuit board (image by Remko van Dokkum).

All of these processes are designed for functionality at the expense of aesthetic freedom—the breadboard and protoboard limit creators to a grid and PCB design CAD tools are

optimized for simplifying circuit design at the expense of aesthetic flexibility. As a result, the artifacts produced by these methods often look very similar to each other—a plastic brick with arcs of wires and components pressed together or a rigid circuit board with components soldered to it.

Interesting to note is the method of handcrafted circuit board design that called Dot and Tape, which was commonly used before CAD design software became prominent (Figure 2.4). Here, circuit designers used pre-cut sheets of stickers with pads that matched the footprints of circuit components and tapes to designate circuit connections (Maxfield, 2011). Such a construction method gave designers freedom to draw the two-dimensional graphic layout of their circuit using stickers and tape, just like the paper electronics method presented in this dissertation, preserving the mark of the creator’s hand in the aesthetic of the finished circuit boards. However, rather than producing the final board directly, the result of Dot and Tape construction is a photographically-derived Mylar mask that needs to be translated into a circuit board through etching a copper plate, losing some tinkerability in the translation.



**Figure 2.4.** From left to right: freehand design of envelope follower using Dot and Tape on Mylar by Joseph A. Paradiso; component placement (above) and circuit board pattern (below) for voltage-controlled amplifier from Radio-Electronics magazine<sup>7</sup> and etched circuit board by Douglas W. Jones.

More recently, researchers have taken a different approach to building circuits by starting with craft materials and translating them into functional materials for building electronics. E-textiles—creating electronics using conductive thread, fabrics and fasteners—is one of the most mature mediums in this domain to reach the hobbyist community. Early practitioners found new techniques like creating textile sensors through embroidering with conductive threads and weaving conductive fibers to create electronically active fabrics (Post et. al. 2000). Since this time, toolkits like the sewable Lilypad Arduino (Buechley and Hill, 2010) and research into low-cost and easy to create textile sensors (Perner-Wilson et al, 2010) have taken such techniques out of the lab and

<sup>7</sup> Simonton, J. (1973). “More synthesizer modules.” Radio-Electronics. Sept



into the wider creative communities including hobbyists<sup>8</sup> as well as professionals<sup>9</sup>. These techniques are also emerging in industry through manufactured conductive textiles for wearable electronic clothing, like Jacquard (Poupyrev et al., 2016) and touchscreen gloves with conductive yarn fingertips to enable use with capacitive touch screens. These are shown below in Figure 2.5.



**Figure 2.5.** From left to right: Embroidered key pad by Post et al., Lilypad Arduino toolkit by Leah Buechley, crocheted tilt sensor by Hannah Perner-Wilson and interactive textile woven on industrial loom by Poupyrev et al.

Such new techniques provide a powerful alternative path for creators to engage with building electronics, allowing them to make with soft materials that are pleasant to the touch, use craft tools and techniques they may be more familiar with, like sewing and embroidery, and design with aesthetics as well as function in mind. By using such tools, researchers have seen more diverse engagement in creating electronics and computational textiles, especially from women and girls (Buechley and Hill, 2010 and Bender, 2016), where in a study from 2010 by Buchley and Hill, 65% of Lilypad Arduino projects online were created by females while 87% of traditional Arduino projects were created by males. The e-textile community has also created artifacts that look and behave differently from traditional hobbyist electronic projects, like electronic fashions and interactive plush toys.

Following a similar materials-based approach, numerous other craft-based electronics toolkits and construction techniques have emerged. For example, Squishy Circuits uses conductive and nonconductive play-dough to enable users to sculpt circuits (Johnson and Thomas, 2010) and Shrinky Circuits uses a common craft polymer sheet that shrinks with heat to produce circuits that are made more robust with miniaturization (Lo and Paulos, 2014). Paper electronics—which uses conductive media and electronic components on paper—is another such category of craft electronics, which I describe in more depth in the next section.

---

<sup>8</sup> Stern, B. (2010). “Geek chic: massive e-textiles roundup!” <http://makezine.com/2010/04/06/geek-chic-massive-e-textiles-roundu/>

<sup>9</sup> WEAR. (2016). <https://www.wearconferences.com/>

## FLAT, FLEXIBLE & PRINTED CIRCUITS ON PAPER

Paper-based circuits have been available since the 1960's with Bacon's research with transistors on paper (Bacon, 1968) but it was not until decades later with the discovery of new electronically active organic molecules and polymers, nanomaterials and printing processes that the idea of inexpensive flexible circuits on paper substrates truly took hold.

For good reason, as paper is both porous (and so absorbs and disperses many inks to the detriment of the circuit) and irregular in surface texture, it is challenging to produce regular and electrically reliable prints. The organic fibers within paper itself also introduce irregularities both chemically and mechanically. Finally, paper is very hygroscopic and can swell as much as 20% upon exposure to humidity. This changes the paper surface geometry, which can cause breakage in printed electrical connections, and change the electrical properties of the paper substrate (Tobjork and Osterbacka, 2011).

Nevertheless, researchers have managed to overcome these challenges—or even take advantage of them—to create a variety of paper-based electronics, including sensors, energy generating devices and displays.

Depositing on or treating the paper with electronically active chemicals can create a variety of paper sensors (examples shown in Figure 2.6). Due to the change in electrical properties of paper upon exposure to humidity, there are a variety of ways to create paper-based humidity sensors. One common approach is to print interdigitated electrodes on paper and monitor the conductivity between electrodes (Andersson et al., 2012 and Kim et al., 2013) shown in Figure 2.6, left. Koehly et al. developed a bend sensor by mixing conductive carbon ink in an elastomeric medium, tinting paper with this mixture and detecting the change in resistance of the conductive band when bent or stretched (2006). By printing electrodes on paper and running signal processing on a combination of capacitive and resistive sensing raw data, Gong et al. was able to create bend, fold and touch sensors using a single conductive pattern (2014).

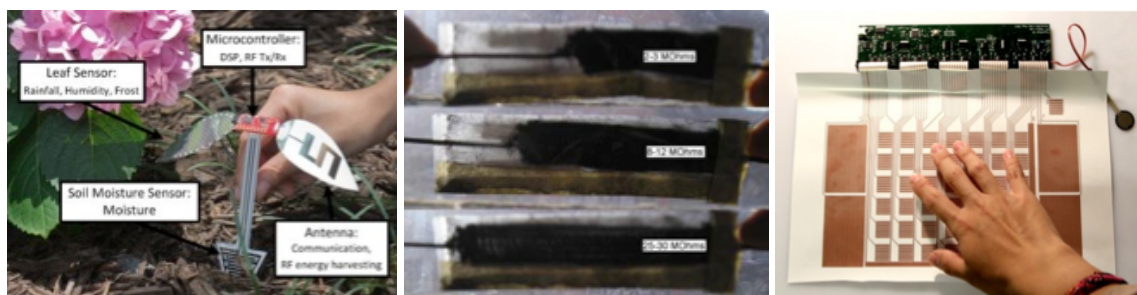

Figure 2.6. Printed humidity sensor by Kim et al. (left), paper bend sensor by Koehly et al. (center) and bend, fold and touch sensor by Gong et al. (right).

Methods have been found to generate voltage using paper-based circuitry, which can be used as sensors or energy harvesters. For example, Karagozler et al. have created paper power generators that harness electrostatic charge generated through vibration and rubbing of printed electrodes to produce voltage (2013), shown in Figure 2.7, left. Researchers have also successfully made light-sensitive paper by printing conductive polymer electronics on untreated paper (Figure 2.7, right). These produce a voltage when exposed to light and thus can act as a solar energy harvesting medium or paper light sensor (Barr et al., 2011).

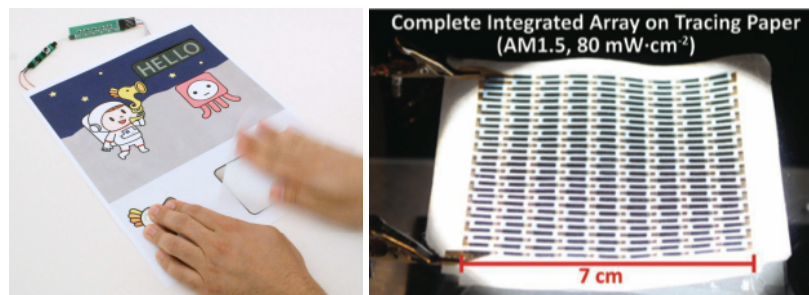
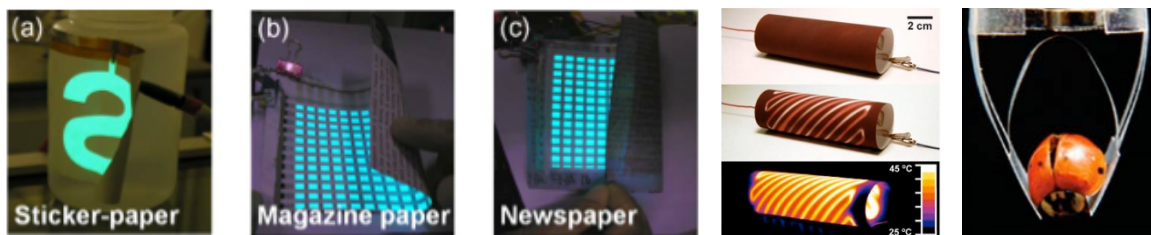

Figure 2.7. Printed power generator by Karagozler et al. (left) and printed solar panel by Barr et al. (right)

In addition to sensing, paper can act as a substrate for electronic displays and outputs (Figure 2.8). For example, Kim *et al.* created a flexible, electroluminescent display with inorganic powder on glossy paper, sticker paper, magazine paper and newspaper substrates by creating a sandwich of printed electrode, phosphor and a transparent indium tin oxide electrode (2010). Siegel *et al.* created thermochromic displays on photo paper by patterning resistive heat electrodes on one side and coating the other side with thermochromic ink so that when current ran through the electrodes, the ink changed color (2009). Chitnis and Ziaie have created a magnetic actuated paper by laser etching wax paper to create hydrophilic channels, coating these areas with ferrofluid, and heating the paper so that the wax flows back over the channels, encapsulating the ferrofluid. With these selectively “printed” ferric regions, the paper could then be electronically actuated through electromagnets (2012).



**Figure 2.8. From left to right: electroluminescent display on sticker paper, magazine paper and newspaper by Kim et al., thermochromic paper display by Siegel et al. and ferrofluid paper actuator grasping ladybug by Chitnis and Ziaie.**

While these research explorations show us what is possible for experts to achieve in a laboratory, other researchers like myself focus on using readily accessible materials and equipment and are designing tools to make paper electronics a medium for beginners and the general public.

Perner-Wilson explored thermochromic displays through a DIY approach in her Kit-of-No-Parts experiments, which she shared through online documentation, tutorials and workshops (Figure 2.9, left and center). She created a gallery of versatile effects by varying the heating element behind a thermochromic painted page—from conductive graphite ink to conductive metal threads (2011). In my own work I have explored and documented ways for beginners to make simple electronic paper actuators with off-the-shelf shape memory alloys (Qi and Buechley, 2012), shown on the right of Figure 2.9.



**Figure 2.9. Thermochromic paper displays with conductive graphite paint (left) and conductive thread (center) by Hannah Perner-Wilson and actuating paper with shape memory alloy (right).**

One popular thread of research within the DIY HCI community is using traditional paper and craft materials that happen to be conductive as wiring to build circuits (Figure 2.10). Pulp-based computing is a process for embedding electronic components and conductive ink directly into pulp during the paper making process (Coelho et al., 2009). Researchers have found techniques for building circuits on paper through techniques like gold foil gilding (Saul et al. 2010) and screen-printing conductive inks (Shorter et al., 2014). Conductive inks and paints to draw (Russo et al., 2011) and inkjet print (Kawahara et al., 2013) circuits on paper have matured enough to be in commercially available products like the Circuit Scribe<sup>10</sup> and Agic<sup>11</sup> toolkits for drawing circuits. In my work, I use conductive foil tape as the wiring, which I find to be both inexpensive and thus easily accessible to hobbyists, versatile since it works with any surface that tape sticks to and is

<sup>10</sup> Circuit Scribe. (2016). <http://www.electroninks.com/>

<sup>11</sup> Agic. (2016). <https://agic.cc/en/>



solderable, and is more reliably conductive and robust than current inks and paints (Qi and Buechley, 2014).

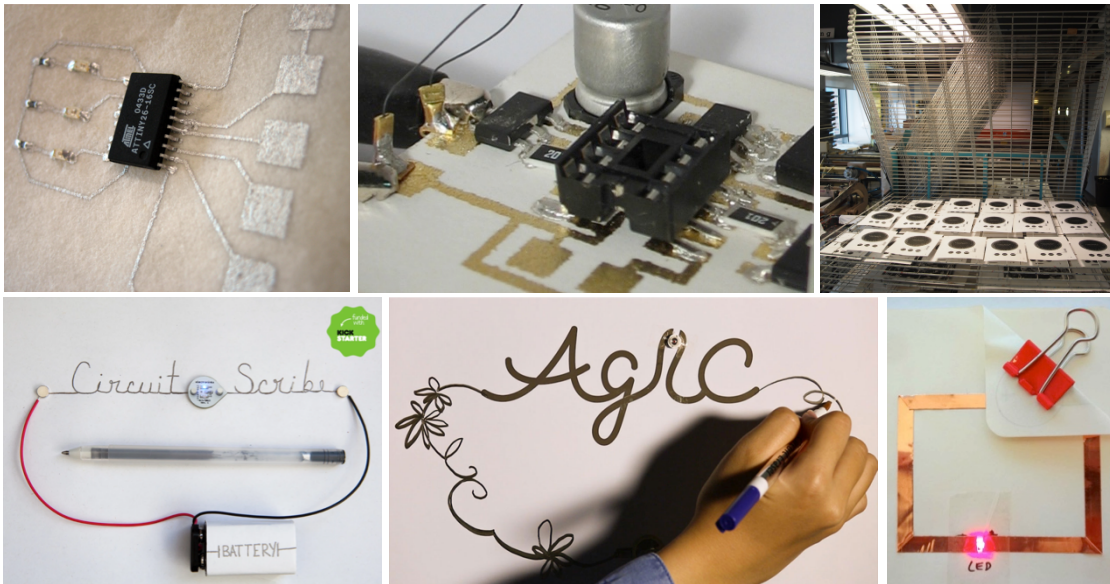

Figure 2.10. Top row, left to right: pulp-based computing by Coelho et al., gold foil gilded circuit by Saul et al. and silkscreen printed circuit by Shorter et al. Bottom row: drawn circuits in Circuit Scribe conductive ink (left) and Agic conductive ink (center) and copper tape circuit (right).

In addition to the conductive traces on paper, toolkits like the Teardrop explores creating custom electronic modules designed for paper. This computational toolkit has sensors, outputs and a programmable Arduino in the form of movable, flat magnetic modules. Shown on the left of Figure 11, these cling to any sort of conductive traces on the page, such as conductive paint or foil traces, and add computation to paper circuitry (Buechley et al., 2009). Similarly, the center of Figure 2.11 shows StoryClip uses a circuit board with clips that attach to the edge of a page and turn painted traces into capacitive touch elements for interactive storytelling (Jacoby and Buechley, 2013). However, not all paper electronics modules need to be custom made. For example Mellis et al. takes an “untoolkit” approach by using off-the-shelf microcontrollers, bending out the legs and gluing them onto conductive traces to connect to paper circuitry (right of Figure 2.11).



**Figure 2.11. Left to right: magnetic modules for paper computing by Buechley et al., Storyclip by Sam Jacoby and example paper circuit with off-the-shelf components from workshop by Mellis et al.**

My own toolkit designs use flexible materials for the modules themselves, with the focus being to design for as much material compatibility and flexibility with paper as possible while maintaining reliable electronic functionality. That is, I hope to create tools that give learners and creators as much of the affordances of paper and electronics separately, and not lose these affordances in the process of combining them.

# 3. Paper Electronics

This chapter gives an overview of my design contributions to paper electronics. I first present my explorations in taking paper electronics and integrating them into book structures, called electrified books. Next I share the design and development of the circuit stickers construction kit and supporting learning resources for making paper electronics more accessible. Finally I describe how we launched the circuit stickers toolkit as into the wild as Chibitronics.

## **ELECTRIFIED BOOKS**

Bound books—collections of many pages within a protective cover enclosure—has long given readers a compact, physical structure for accessing information and content. With the advent of digital technologies, much of this has moved to screen-based digital books on electronic devices like e-readers, laptops and smartphones. However, books remain an object of interest for many researchers who are exploring the dynamic possibilities of electronics combined with the physical affordances of bound books (Freed et al., 2011).

There is a substantial history of digitally augmented notebooks, such as the *a-book*, which combines a WACOM tablet for capturing writing on paper and PDA for displaying corresponding digital information (Mackay, 2002). Commercially available tools like Anoto<sup>12</sup> allow users to digitize handwritten notes in real time and annotate handwritten notes with audio recordings. This is done through notebooks with special printed reference patterns and a special pen that has a built-in camera for reading its location on page.

Other commercially available combinations of electronics with books include children's storybooks that are augmented with sound. Some storybooks have sound boxes attached to the cover<sup>13</sup> with buttons for readers to press to trigger a sound. More recently, Recordable Storybooks<sup>14</sup> allow readers to record themselves reading the story and then play back the reading when the child flips through the book. The electronics are embedded in a case on the back cover of the book and page detection is done through a row of light sensors and corresponding holes in the page. Commercially available electronic greeting cards, which employ similar blends of paper with circuitry, are

---

<sup>12</sup> Anoto. (2016). <http://anoto.com/>

<sup>13</sup> Sound books. (2016). <http://www.usborne.com/catalogue/subject/1~EY~BBN/noisy-and-musical-sound-books.aspx>

<sup>14</sup> Recordable Books. (2016). <http://explore.hallmark.com/recordable-storybooks/>

manufactured by embedding the circuit board in an envelope enclosure made by folding the paper around the PCB.

Focusing on embedding electronics into the book structure, researchers have electronically-augmented picture books to engage young readers in new ways with sound (Back et al., 2001 and Monache et al., 2012), dynamic storylines (Yamada, 2010) and digital displays (Vogelsang and Signer, 2005; Grasset et al., 2007 and Sylla et al., 2007). Others have also made tools for creators to design and build their own electronics on notebooks like Buechley's teardrop toolkit (Buechley, 2009), which I also used in my early explorations with an electronic pop-up book (Qi and Buechley, 2010). Another early collaboration, Telescrapbooks are wirelessly connected scrapbooks that use sticker electronic modules and pre-built electronics books to enable electronics novices to create their own electronic books (Freed et al., 2009). For page detection, we embedded magnets on each page and a row of Hall effect sensors on the back cover. Other research in page detection, an important affordance of electronically-augmented books, include printing conductive ink on each page and measuring the change in resistance as the pages are bent (May, 2001) and using embedded RFID tags (Back and Cohen, 2000).

The remainder of this section gives an overview of my current design explorations in paper electronics assembled into book structures, which I call *electrified books*. In particular, I look at how electrified books can be applied to designing and prototyping circuits in sketchbooks, teaching electronics through an activity book and an illuminated picture book for storytelling.

## **Circuit Sketchbooks**

Building circuits on paper comes with the affordances of documentation and archiving—the individual electrified pages can be compactly collected into books. How would this change the circuit design and building experience? Exploring this idea, the following are three approaches to creating a sketchbook for circuits. Every functioning circuit needs a power source, so we began by adding these to the bound book form.

One option is to create a custom bound book that interfaces with a removable power clip. The sketchbook is composed of pages folded in half—called folios—stacked together and stab bound into a book (Figure 3.1). All folios have two conductive foil stripes taped across the spine in the same place, so that when stacked corresponding conductive foils touch. When bound together, these patches create a conductive track along the spine of the book and are accessible on alternating spreads inside the book.

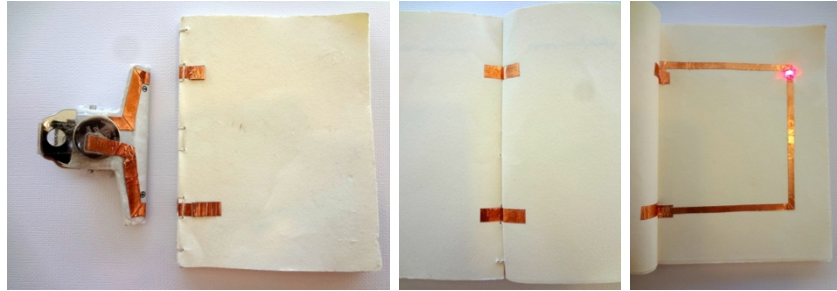

Figure 3.1. Custom bound book with battery clip, interior with power tabs, example circuit.

The power clip is composed of a standard wide document clip, insulated to prevent short-circuiting to the clip's metal body. A coin cell battery is taped in place with two foil traces leading to the mouth of the clip. These leads are designed to match the conductive foil track on the spine of the sketchbook. When the power clip is attached to the book, every page is connected to the power supply. This allows users to power multiple pages simultaneously, or if desired, use switches for powering individual pages. This approach is designed to allow a single removable power supply to power multiple circuit sketchbooks. A future revision may include a power clip that also functions as a cover, so that the pages within function like inserts in a binder and can easily be removed and reordered.

A more integrated option is to permanently embed a rechargeable power supply inside a standard sketchbook (Figure 3.2). Here, I deconstructed an off-the-shelf USB phone charger and embedded the circuit with rechargeable battery into the back cover of a standard sketchbook. The goal was to make the sketchbook look and feel as much as possible like a traditional book, so that the circuit sketching process would feel more like typical drawing or writing experiences with a notebook. The USB connector and on/off switch are on the top and bottom spine extremes of the book, respectively, and LED indicators for power status and battery life are on the outside spine.

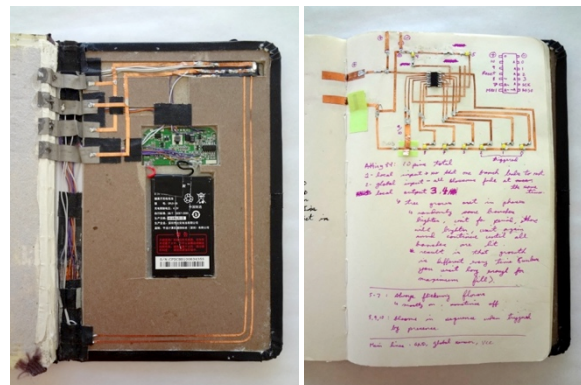

Figure 3.2. Rechargeable sketchbook with charging circuit in the back cover (left) and interior showing power tabs and example circuit with notes (right).

To connect the power output of the circuit to the pages of the sketchbook, first we unbound the sketchbook and added two conductive foil tapes to both sides of every folio along the centerfold. We then sewed these folios back together into signatures with standard nonconductive thread. Next, we connected conductive fabric tapes to the positive and negative leads of the power output and sewed the signatures to the conductive fabric tapes using a separate piece of conductive thread for each tape. This places two conductive foil tabs—positive and negative leads to the power supply—in the center of each spread. All tabs are powered when the book is turned on.

The last and most accessible approach to creating a circuit sketchbook is simply building circuits on the pages of a standard book, using a removable power supply for each page. For this third model, we used the coin cell battery and binder clip to create a collection of circuits in a standard sketchbook (Figure 3.3). In this setup, the battery can be stored with the notebook by simply clipping it in place with the binder clip.

This method is most accessible since it only uses off the shelf parts but preserves the sequential, and archival qualities of building circuitry in a sketchbook format. Also, by using a normal sketchbook, there is less worry about preciousness—in the other circuit sketchbooks there was a sense that powered pages should not be wasted. Even though these tools were designed for experimentation, their limited pages discouraged mistakes and waste. As a result, the powered sketchbooks were used more for display and archiving rather than sketching, testing and experimenting.



**Figure 3.3. Standard sketchbook with coin cell and binder clip power supply. Example page.**

As a first look into using sketchbooks for circuit building, I ran a preliminary workshop with a group of high school students using standard sketchbooks and removable batteries (Qi and Buechley, 2014). We first made five circuits together, each circuit on a different page of the sketchbook: simple single LED circuit, parallel circuit, switch, sliding blinking switch and pressure sensor. After building each circuit, students were encouraged to decorate their circuitry. Then the students were free to create their own projects using these new techniques (shown in Figure 3.4).



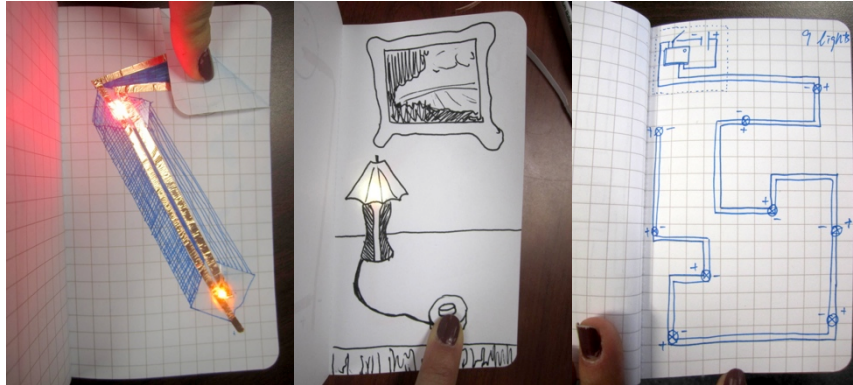

**Figure 3.4. Sample student circuit sketchbooks. Decorating around the circuit (left), illustrating a light (center), planning a circuit (right).**

The goal for the sketchbooks was to make a useful platform for circuit prototyping. However, results seem to show participants prefer using these for documentation, archival and sharing. While the participants did not use the sketchbooks as a place for prototyping circuits, they did flip through their examples many times in the process of brainstorming ideas and ways to implement their final projects. As such, the book of functional circuits worked as an encyclopedia—filled with inspiration—as well as a notebook, reminding participants how a particular circuit is constructed.

The sequential nature of the pages showed a learning process and strand of thoughts that went into producing the circuits. Participants often decorated their circuits with a particular theme or even narrative thread. The sketchbooks also provided a protective cover—the pages and the cover of the book itself—for circuits created, allowing students to toss them into their bags without worrying about damaging the circuit. The sketchbooks allowed many circuits to be compiled and organized into one portable object, making them handy as participants were able to carry their entire collection of circuits in a compact and easily retrievable form.

Finally, because they were so portable and personalized, many participants enjoyed sharing and trading their circuit sketchbooks with each other to show off both the different circuits they created as well as the personalized illustrations that accompanied the light effects.

As I further develop the circuit sketchbook idea, beyond serving as a portable power supply, I hope to make the sketchbooks more supportive of the electronics design and prototyping process. I imagine embedding a programmable microcontroller, in addition to the power supply, into the cover to add computation and encourage users to use their sketchbooks for documenting and prototyping software as well as hardware.

## Learning & Teaching: Circuit Activity Books

Books are powerful tools for not only recording information but also for sharing it. In particular, I was interested to see how electrified books could be used to teach paper circuitry.

Paper circuitry also has the unique property of bring both the functioning circuit and the schematic diagram, making it easy to create printed templates (schematics) which guide learners on how to build their circuit (Qi and Buechley, 2014). Combining these two techniques, I created a Circuit Activity Book, which is a collection of templates, explanations and activities as an introduction for beginners to basic paper circuits.

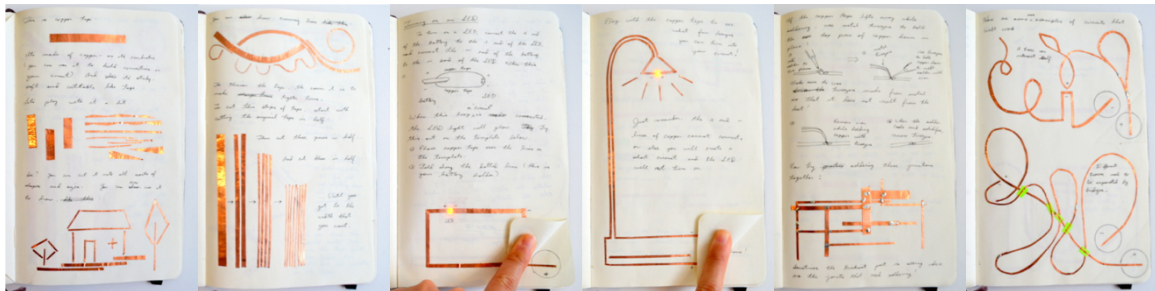

Figure 3.5. Sample pages from initial Circuit Activity Book.

My approach was to take individual templates and compile them into a series with explanations, questions and exercises printed alongside the circuit. The initial prototype (example pages shown in Figure 3.5) began by introducing copper tape as a drawing material and gave tips and exercises for learners to practicing cutting, folding and drawing with the tape. Only after learners were familiar with the material did I go on to introduce the basic LED circuit. Following this introduction is an LED circuit made in the shape of a lamp, to remind learners of the expressive possibilities. I then introduced more advanced techniques like soldering and isolating bridges so that the conductive traces can overlap. Finally, I concluded with example variations of circuits that would work as well as examples of common mistakes and how to correct them.

The beauty of using printed circuit templates instead of actually printing functional circuitry onto the page is that it only takes traditional printing processes, which is affordable and much more scalable. This early prototype Circuit Activity Book laid the foundations for the Circuit Sticker Sketchbook, which was indeed produced at scale through manufacturing processes and published (see *Chibitronics* section of this chapter).



## Storytelling: Ellie the LED

My final experiment was to explore how electrified books can share information by telling stories, especially how electronic interactivity could enhance a reader's experience of narrative. In collaboration with Sonja de Boer, I created an electrified bedtime picture book titled *Ellie*, a book about an LED light named Ellie who dreams to be a star.

We designed the book to prioritize narrative over technology—that is anything electronic must be there in service of the story and we did not want to incorporate an interaction for the novelty of it. For example, our main character Ellie was both illustrated and illuminated as an LED (upper right of Figure 3.6). We depicted her expressions both through graphical drawings as well as playing with patterns of light. For example, when she is calm, Ellie fades slowly in and out while when she is excited she blinks very quickly and brightly. We also experimented with diffusion techniques using felt to create different sizes and shapes of diffused LED light, so that the scene could zoom out to show the grandeur of the starry sky or zoom in to Ellie's face to highlight her emotions. We also used animation, for example when Ellie flies across the sky or when the stars twinkle, to introduce a sequential time dimension and add dynamisms to the page.

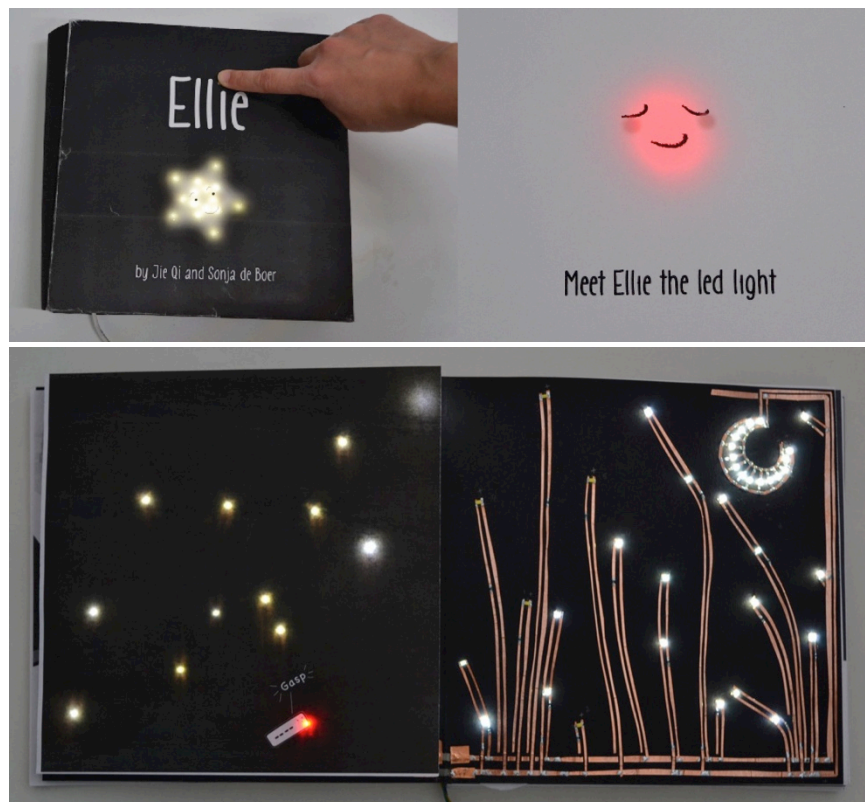

Figure 3.6. *Ellie the LED*: press cover to turn on (upper left), Ellie the illustrated and illuminated protagonist (upper right) and spread showing illustration and circuitry (below).

We constructed the book using an accordion book structure, which allowed conductive traces to connect between multiple pages through the spine. When the reader turns on the book, the entire book illuminates (Figure 3.6, upper left). This way, readers can flip through quickly without needing to wait for pages to turn on as well as browse multiple pages in their activated state at the same time. When the story is over, the cover of the book illuminates, acting as a night light for the young reader.

After completing the storybook, we realized that despite having dynamic animations and effects, the lights blended in too much with existing illustrations so that they did not appear significantly different from traditional illustrated scenes without electronics. In the future we may experiment with simpler drawings that reduce visual clutter around the LED light. We also found that there was not enough interactivity to the pages. Our original thought was that unnecessary interaction would distract from the story. However, we may have gone too far in the opposite direction by not taking advantage of interactive possibilities to better engage the reader in the story, and created what felt more like a typical storybook experience. In future versions, we will start by prototyping engaging experiences independent of the story and choose those that fit within our story, so that we have both engaging interactivity as well as a strong narrative that reinforce each other.

## **CIRCUIT STICKERS**

Up to this point, I relied on only affordable and off-the-shelf components so that creators outside of the lab would be able to create with this medium. To build circuits on paper, a typical method was to use standard bulb-shaped LED lights by bending the legs outward and taping them to the circuit. However, these LEDs were often too bulky to incorporate into projects like books. Another method was to use standard surface mount LEDs with clear tape or soldering to create low-profile circuits on paper. However, this also meant crafting with components the size of grains of rice, or smaller, which require both strong eyesight and manual dexterity, making it inaccessible for many learners and creators. I realized the need for a circuit building toolkit designed specifically for paper electronics.

To investigate a custom alternative for paper electronics, we began exploring stickers as a form factor for electronic components. The metaphor of the sticker—a pre-assembled, thin and flexible unit to be stuck anywhere—was important as a friendly and familiar medium to most users through which to introduce the new concepts of circuit building. As modules, they allow us to pre-package individual circuit components into more functional electronic modules. Stickers are also a functionally versatile material, being

both flat and flexible, they can integrate well with paper and stick to many other surfaces. Finally, aside from technical functionality, stickers are a quick and simple way to decorate and personalize our things—simply stick them down or move them around—which has made them particularly appealing as a creative material.

We first created electronic sticker modules as part of the Telescrapbook project, which used sensor and output stickers called I/O stickers to simplify circuit building for beginners (Freed, 2011). An example is shown in the left of Figure 7. While this project proved the concept of sticker-based circuit building as a successful interaction, since these stickers were handmade one-by-one, it was not scalable as a creative raw material.

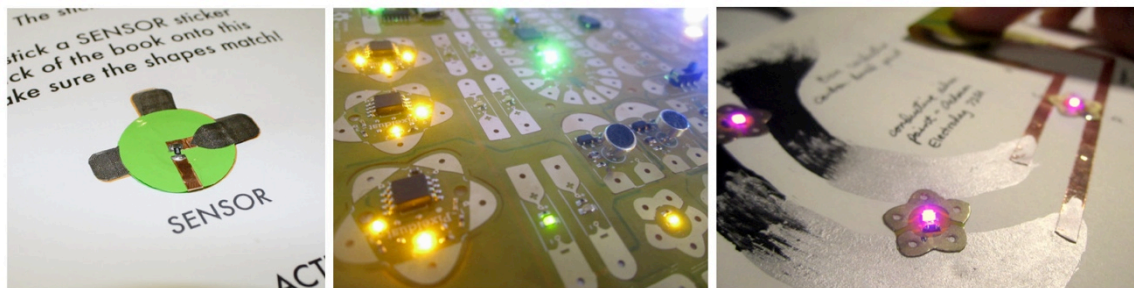

**Figure 3.7. Sticker circuit prototypes. I/O sensor sticker from Teleacrapbook (left), preliminary set of manufacturable circuit stickers (center) and test of manufactured circuit sticker with conductive foil tape and conductive paints (right).**

To explore circuit stickers at scale, I collaborated with hardware designer and manufacturer Andrew “bunnie” Huang to design and prototype a set of sticker modules using manufacturing processes (Qi et al., 2015). The new stickers were fabricated by adding conductive z-axis adhesive to flexible circuit boards, a process developed in collaboration with Yoshihiro Kawahara, professor at University of Tokyo, and Steve Hodges, scientist from Microsoft Research (Hodges, 2014). The z-axis adhesive is crucial to this process because it only conducts along the axis between the top and bottom surface of the adhesive, we can apply it to an entire sheet of circuits without short circuiting individual pads to each other, simplifying the manufacturing process dramatically. This material is also commercially available and relatively affordable, for example a 50mm x 150mm sheet of the adhesive—which comes in the form of double-sided tape—costs approximately \$5 USD. We began by prototyping a wide variety of circuits and shapes, including decorative star-shaped sticker LEDs, battery charging circuits, accelerometers and a programmable Arduino (center and right of Figure 3.7).

To create our prototypes, we used traditional flexible PCB manufacturing to build the boards. This involved etching into copper-plated polyamide sheets and then soldering

electronic components. Afterward we laminated sheets of z-tape adhesive to the back of the circuit board, baked them to optimize adhesion and then sent the boards through a die-cutting process. We created custom dies to simultaneously cut only through the circuit board layer to separate the individual sticker components, as well as cut through the entire lamination to separate multiple clusters of stickers. Through several iterations, we came up with a mostly-automated process that reliably produced circuit stickers.

## **CHIBITRONICS**

With circuit stickers proven to be manufacturable, our next step was to design an introductory kit, secure resources, scale the manufacturing and distribute the toolkit out into the world. This section details the design, implementation and deployment of our circuit stickers toolkit and accompanying guidebook *Circuit Sticker Sketchbook*, which we call Chibitronics.

### **Cute and Open**

With the goal of making our tools as friendly and accessible as possible, our design philosophy was guided by two themes: cuteness for friendless and openness for accessibility.

The name Chibitronics is a combination of “chibi,” which is a style of cartooning where characters are drawn to be small and cute<sup>15</sup>, and a shortened form of the word “electronics.” With this term we hope to convey that though circuitry is often perceived as intimidating or even dangerous, we can also make circuitry be friendly, playful, simple and harmless, which is embodied in our idea of cute. Some of this is simply in how we design the materials and tools.

It is interesting to look at the evolution of the mass-manufactured toy doll industry for comparison. While soft, homemade ragdolls had been around to teach girls domestic skills, when the American mass-manufactured toy industry first emerged after the Civil War, manufactured dolls were made of hard materials like wood and metal. These dolls had fully articulated joints to accurately mimic the movements of the human body and were “mechanical or machinelike,” possibly as a reflection of “a business economy dominated by male entrepreneurs fascinated with technology and the scientific management of production processes” (Ngai, 2005). In fact it was not until decades later, when female doll makers began mass manufacturing dolls from textiles with a focus on

---

<sup>15</sup> Chibi. (2016). <https://www.wordnik.com/words/chibi>

qualities that make dolls more suitable to young children, like softness and light weight portability (Formanek-Brunell, 1993).

In the same way that when mass-manufactured dolls first began as rigid replicas of the human body, which celebrated the technological achievements of manufacturing but somewhat left behind the needs of children for soft and safe toys, I see a similar pattern in the current state of electronics manufacturing. While e-textiles are a growing field within electronics production, it remains niche. The mainstream circuitry mass manufacturing industry is still dominated by precise, rigid, and sharp objects made from hard materials. As a result, entire genres of circuitry are not being produced, possibly because such alternative aesthetics and material properties like cuteness and flexibility have not been as widely embraced by the industry.

By manufacturing Chibitronics as a flexible alternative to traditional rigid circuit boards, they become not only more versatile as a material but also more comfortable to the touch. By also designing them to follow a cute aesthetic, we hope to begin manufacturing circuitry that challenges mainstream concepts of what circuitry can be, that is, cute, simple, flexible and friendly.

In circuit stickers and sketchbook design, we use rounded shapes, miniaturization and simplified images with thick outlines, which are all elements of cute product design (Cho, 2012). The sticker modules are rounded in shape and use similarly simple, rounded shapes for the pads. The stickers themselves are relatively small but still of a comfortable size to manipulate easily by hand. Likewise our *Circuit Sticker Sketchbook* is a miniaturized pocket-sized book. Its shrunken pages offer enough space to be creative but is restricted enough in size so that beginners are not intimidated by too large of a blank surface. The diagrams inside the book are also simplified into a cartoonish style with simple colors, which makes them both cute and easier to decipher.

To make the stickers not only appealing but also accessible, we also designed with openness in mind. Openness takes many forms. In terms of the electronics, this means creating stickers with circuitry exposed, so that creators have full access to the workings of the circuit and can explore if they wish. It also means releasing our design files, code, videos and print resources under open source and creative commons licenses so our creators and contributors can legally replicate and remix what we produce.

As a medium, paper is commonly accessible and printing makes it very easy to replicate the resources we produce. Such an accessible materials also makes it easy for our users to become contributors. For example, all you need is a scanner to turn a paper circuit into a

template for someone else. Or, an educator can simply draw a circuit with a pencil. We take such an open approach in hopes of encouraging users to also become creators of these tools, democratizing innovation within the field (Hippel, 2005) so that the paper electronics medium can evolve faster and better fit the needs of the community.

Having shared our design guidelines, the following sections present the results in the form of our first Chibitronics circuit stickers construction kit, the *Circuit Sticker Sketchbook* and how we released this project out of the lab and into the wild.

## LEDs, Effects, Sensors & Microcontroller Stickers

The Chibitronics circuit sticker toolkit is designed to include the most simple and versatile modules, to enable interactive and expressive variety without overwhelming beginners. Thus far, it includes LEDs, pre-programmed function generating effect stickers, light sensor, sound sensor, resistive touch sensor and a programmable microcontroller (Figure 3.8).

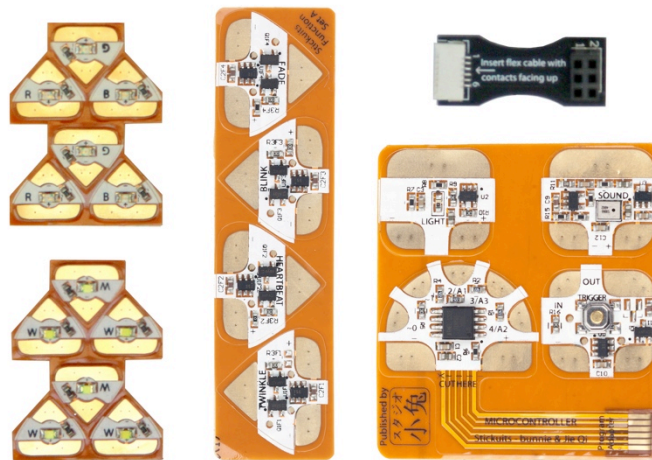

**Figure 3.8. Left to right: LED stickers, Effect stickers, Sensor and Microcontroller stickers and programming connector.**

The LED is the most basic circuit sticker, with two contacts and a power-limiting resistor. Currently the LEDs come in white, red, yellow, blue, orange, green and pink colors. Next, sound and light sensor stickers output voltages depending on light and vibration hitting the sticker, respectively. Finally the touch sensor sends a momentary signal when it senses a change in resistance between two electrodes on the sticker.

These sensors can also be used creatively to sense higher levels of information. For example, in addition to noise in the environment, the sound sensor can sense tapping on the paper or wind (by blowing into the microphone), which all generate vibration. The

resistive touch sensor allows users to turn any two conductive materials into sensor electrodes like in the Makey Makey<sup>16</sup>. For example, users can create scenes where objects drawn in copper tape or conductive ink can be touched to control the brightness of lights. Finally, the light sensor allows “remote” interactions such as by casting shadows or changing ambient light levels, which changes the circuit without directly touching it.

Effects stickers are pre-programmed microcontrollers that automatically generate dynamic patterns: blinking, fading in and out, random twinkling and heartbeat pulsing. Different effects stickers have the same footprint so that the creator can change the pattern by simply switching out one effect sticker for another, giving them access different programmed functionalities without needing to edit code. The goal is first to learn the circuitry for a programmable circuit before learning to code.

Through effects stickers, users get a first taste of the microcontroller—that is, connecting LEDs (or any actuator component) to electronically controlled pins which automatically turn the components on and off in repeating patterns. If the user wants to speed up, slow down or otherwise customize the output pattern, then they can move on to programming the microcontroller sticker.

The microcontroller sticker is an ATtiny85-based Arduino microcontroller. The microcontroller sticker also comes with a default program written in collaboration with Natalie Freed that has one resistive touch sensor and four output functionalities based on this sensor’s reading. One output to highlight is the repeat pin, which saves the pattern tapped on the touch sensor pin and replays this pattern on loop. This enables users to create custom patterns simply by tapping on the sensor, without needing to dive into the code. Our goal is to support programming functionality without the complexity of bringing a computer into the crafting experience.

The stickers were designed to work with a wide variety of materials so that creators could incorporate their medium of choice (Figure 3.9). They stick well to conductive foils and inks on paper, as an introductory medium. The adhesive also sticks to any surface that accepts stickers, such as fabrics for making sewn circuits or glass to make circuits on windows. The stickers have solderable metal pads on top for making more permanent connections and thus give creators an on-ramp to working with traditional electronic components and fabrication techniques.

---

<sup>16</sup> MakeyMakey. (2016). <http://makeymakey.com/>





**Figure 3.9.** Circuits stickers used with a variety of conductive materials including conductive ink, tape, foil, pencil graphite, thread and soldered to wire.

Creators can undo and redo their sticker circuits by peeling and re-sticking, just like with regular stickers. However after a handful of times peeling and sticking, they will eventually lose their stickiness and thus their electrical connectivity. In this situation, creators can recycle their stickers by cleaning off the old adhesive and applying new conductive adhesive or use an alternative conductive connector like a conductive fabric patch<sup>17</sup>. Our goal is to make it okay to tinker and make mistakes with circuit stickers. In future iterations, we would like learners to be able to peel back the stickers as many times as needed and only when ready are the stickers stuck down for permanent projects.

We also designed the shapes of the stickers to be graphical representations of the function of the electronic elements so that users could “read” the sticker to figure out how to use it. For example, the LED sticker was designed to look like the triangle of a diode symbol, where the point is the cathode and the wide end is the anode. Not only does this begin to introduce traditional electronic component notation, it also subtly prompts makers to consider the directional flow of electricity through the circuit.

### **Circuit Sticker Sketchbook**

In addition to the circuit stickers, there must also be the resources to help support and inspire the use of these new tools. The *Circuit Sticker Sketchbook* is a guide that both teaches the theory behind how a circuit works and provides space for users to craft functioning circuitry right into the book (Qi, 2014). The design of this book is based on workshop feedback from the electrified notebooks as well as the Circuit Activity Book described in the previous section. The power supply is a movable coin battery, which can be clipped to the book for storage. The sketchbook is small and light so that it can be carried around and robust enough to endure the journey. This allows creators to craft

---

<sup>17</sup> Conductive Fabric Patches. (2016). <https://chibitronics.com/conductive-fabric-circuit-patches/>



circuits in the classroom, at home, in the park or in a cafe. Our hope is that this will make sketching with circuitry more accessible and feel more like regular sketching with pen in notebooks.

The pages of the sketchbook itself are meant for building. Beginners are guided by templates to build working circuits right on its pages, much like coloring in the lines but with copper tape and LEDs instead of markers. Completing the activities lets learners experience the physical process of making circuits. The completed book also acts as a guide with functioning examples to look back on for inspiration and technical review when moving on to personal projects. This style of offering both functional and instructional examples in the book is inspired by *The Elements of Pop-Up*, which creates an analogous gallery for paper engineering mechanisms (Carter and Diaz, 1999).

The *Circuit Sticker Sketchbook* is divided into five chapters, each themed after a circuit concept with complexity building up from single LEDs, to multiple LEDs in parallel, to a switch, to playing with switch geometrically to create a blinking effect and finally to making a paper pressure sensor (Qi, 2012) so that the light can gradually fade in and out. These chapters share both electronics theory and craft techniques, all with a focus on using these to create more interesting paper electronics effects and tell personal stories.

Each chapter begins with an explanation of the circuit, followed by a circuit template with instructions (Figure 3.10). The template is an image with footprints of where the lights, stickers and battery go on the page, so that the reader simply needs to place conductive tape and components over the corresponding parts in the drawing. These templates are designed to give users as much guidance as possible—for example there are labels and directions right on the template—while still providing some space for error to learn exactly what makes the circuit function. Our goal is to help readers have successful circuit building experiences early on so they feel empowered to continue on their own.

After completing the circuit, the user turns the page to see a drawing illuminated by the circuit. For example, in the first chapter the LED illuminates a drawing of a light bulb. The graphic transforms an abstract light into the light bulb shining in an open space. Each page after a circuit template is a pre-drawn graphic to suggest the scene but that is also open-ended and incomplete. This gives room for the creator to fill out the scene with their own ideas and bring in tools that they are familiar with. For example, they can illustrate the scene with markers and ink, craft over it with paper and fabric, or write a poem and highlight parts of the text.

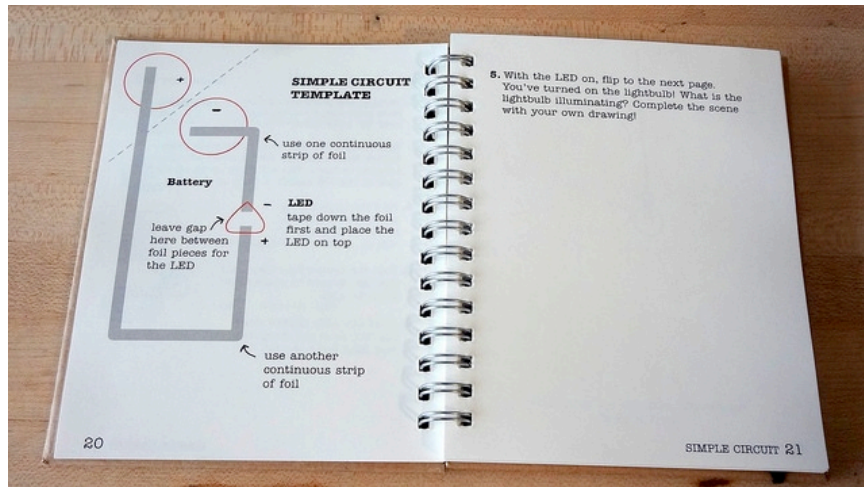

8. With the LED on, flip to the next page. You've turned on the lightbulb! What is the lightbulb illuminating? Complete the scene with your own drawing!

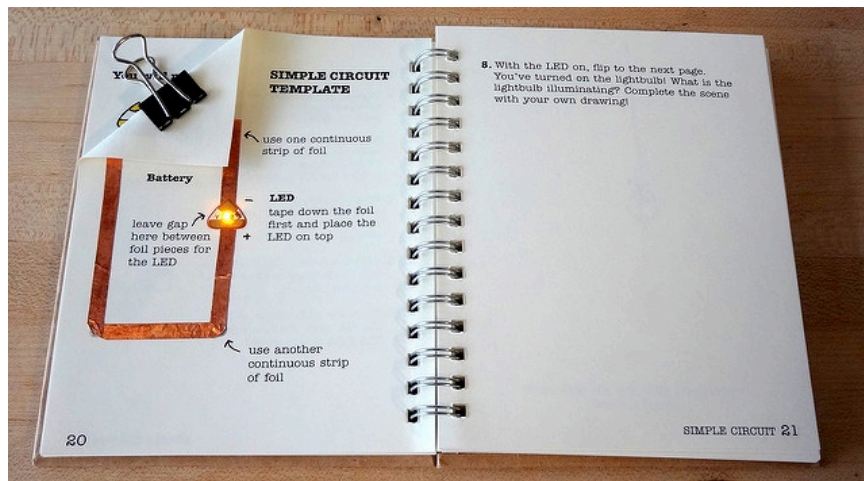

8. With the LED on, flip to the next page. You've turned on the lightbulb! What is the lightbulb illuminating? Complete the scene with your own drawing!

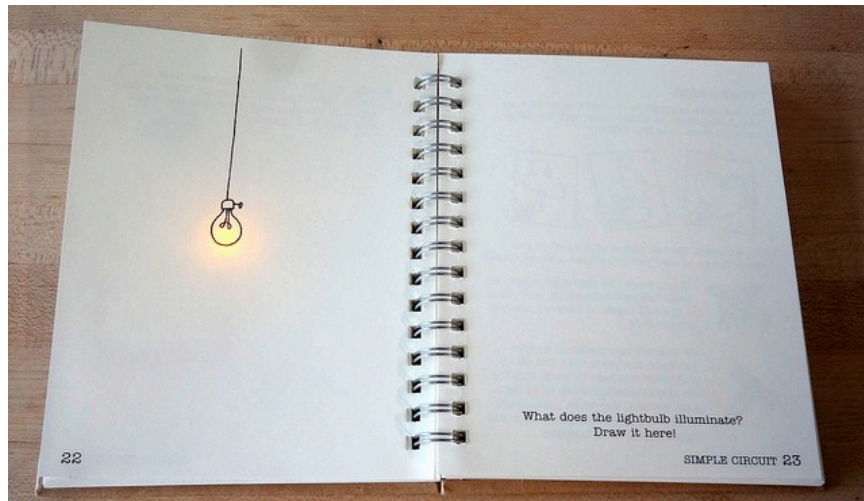

What does the lightbulb illuminate? Draw it here!

Figure 3.10. Sample *Circuit Sticker Sketchbook* chapter: blank template (top), completed circuit (center) and illuminated illustration (bottom)

After the guided circuit template activity in each chapter, there is a blank circuit template with only a footprint for the battery. Here it is up to the users to design their own circuits—to explore and try out applying the new circuit technique in their own styles. If they forget how, users can simply turn back one page to see the functioning example circuit, and then turn back again to see the explanation. This section also presents a craft technique suggestion, such as drawing a pattern or shape with the copper traces. The idea is that once users understand the physics and interaction of the circuit, they are encouraged to also try playing with the material and artistic properties of the circuit. Finally, the last section of each chapter offers more ideas for advanced technical and artistic explorations.

The goal with these circuit craft activities is also to create space for both technical and expressive exploration and problem solving. With technical activities focused on function, there is a “known” right answer in that the user knows when the circuit behaves as intended, or simply “it works.” With expressive activities, there is no “right” answer since it is up to the creator to give personal meaning to scenes they create and to decide when this message has been successfully communicated. Both processes require confidence. In working toward a clear technical end, the creator must believe that he or she is capable of creating the project, endure setbacks and patiently debug until the circuit works as intended. On the expressive side, the user must have confidence in his or her own message and create her own metrics for success.

In putting these two approaches together, these different sorts of confidences and successes complement each other allowing for both hard and soft approaches (Turkle and Papert, 1990). If a creator starts with successfully building a working circuit, the light illustration may help energize him or her toward the next step of creating meaning around the circuit. If the creator comes up with an expressive idea for the circuit first, then the personal desire to express this message may motivate the tinkering and debugging process of making the circuit work.

To further support various styles of learning, we translated the Circuit Sticker Sketchbook into tutorial webpages with downloadable templates and videos showing how to complete the circuit templates. Tutorials and additional resources are also on the website for the sensors, effects and microcontroller stickers.

## Into the Wild

After designing the initial set of manufacturable circuit stickers, we were ready to share them with the world. We first launched the Chibitronics circuit stickers toolkit in November of 2013 (Figure 3.11, left) through a crowdfunding campaign on [crowdsupply.com](http://crowdsupply.com)<sup>18</sup>. We successfully raised approximately \$100,000.00 during the course of the campaign, which provided the resources for us to manufacture and distribute our first batch of circuit stickers toolkits in June of 2014. Following our campaign, we continued to receive interest in these kits and founded the company Chibitronics PTE to handle the legal and financial logistics of continuing to distribute the circuit stickers toolkits at scale. The kits are currently available through various channels, including our online shop at Chibitronics<sup>19</sup> (Figure 3.11, center).

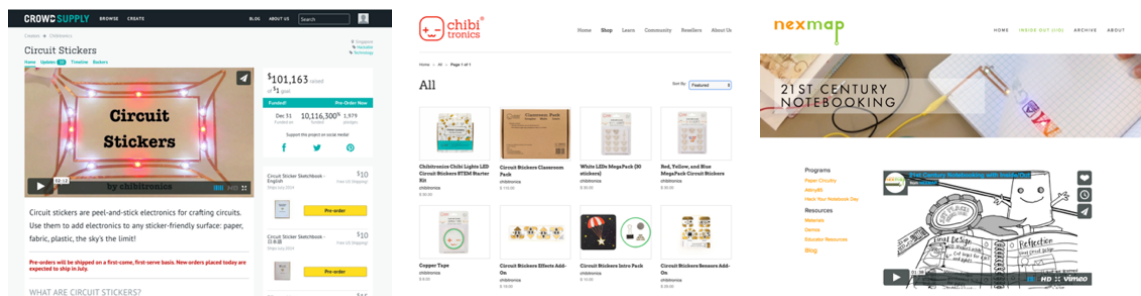

**Figure 3.11. Circuit Sticker crowdfunding page on Crowdsupply.com (left), Chibitronics online shop (center) and 21<sup>st</sup> Century Notebooking website (right)**

After the crowdfunding campaign, we collaborated with David Cole and Jennifer Dick from nonprofits Nexmap and CV2 to found the 21<sup>st</sup> Century Notebooking<sup>20</sup> initiative, which focuses on sharing paper circuitry with educators (Figure 3.11, right). The initiative began with a series of mini circuit sketchbooks based on the Circuit Sticker Sketchbook and has since grown to create many new tutorials, templates and other resources for paper circuitry. The group has also held workshops for educators and students and seeded the growth of the 21<sup>st</sup> Century Notebooking online community.

The 21<sup>st</sup> Century Notebooking initiative further collaborated with the National Writing Project to organized Hack Your Notebook Day on July 9, 2014 (Oh, 2015). We sent out kits with circuit stickers and templates specially designed for the event and on that day educators and students across the US gathered for paper circuitry for webinars, created paper circuitry projects and shared them on live social media feeds (Figure 3.12).

<sup>18</sup> Circuit Stickers. (2016). <https://www.crowdsupply.com/chibitronics/circuit-stickers>

<sup>19</sup> Chibitronics. (2016). [Chibitronics.com](http://chibitronics.com)

<sup>20</sup> 21<sup>st</sup> Century Notebooking. (2016). <http://www.nexmap.org/21c-notebooking-io>



**Figure 3.12.** Hack Your Notebook Day webinars (upper left), map of participation (lower left) and social media feed (right).

After deploying the circuit stickers toolkit and support resources, I wanted to see what people out in the world did with it, whether they are learning, teaching and/or creating with these tools. I hoped to use this toolkit as a means to explore the paper electronics medium in general. The next three chapters provide an initial look. *Chapter 4: Education* evaluates paper electronics as a learning tool by looking at how educators and students have used it in natural learning settings. *Chapter 5: Expression* explores the potential of paper electronics as an expressive medium through engaging skilled artists and creators. Finally, *Chapter 6: Community* investigates what types of individuals and communities are using paper electronics in the wild and what they are doing with it.

## 4. Education

One of my core objectives for creating paper electronics is to make a medium for introducing new learners to designing and creating their own technologies. As a result, it needs to be accessible to learners and useful for educators as tool for teaching electronics. This chapter evaluates paper electronics as a learning and teaching tool. My main research questions are:

- How do paper electronics learning processes and outcomes differ from using traditional tools for learning and teaching electronics?
- How does blending technical functionality and expressive design in particular affect students' learning process?
- How does using paper electronics affect learner engagement and participation?

I'm curious to see how the unique material properties of paper electronics and the blend of designing for technical functionality and expressive communication makes learning through paper electronics different from more traditional approaches for engaging with electronics. I'm especially interested in how paper electronics might enable new modes of exploration and creation that are not possible otherwise, as well as how learning outcomes from these activities may differ and go beyond traditional electronics concepts. Finally, through using this alternative approach, I wanted to see how this might affect which learners engage with the activity, with the hope that it will reach students who typically find topics like electronics intimidating or uninteresting.

To answer my research questions, I interviewed twenty educator lead users and analyzed the publicly available documentation previously created by these educators, independently of the interviews. The educators were selected for their extended and in-depth of their experience with paper circuitry. Some were my early collaborators from the 21<sup>st</sup> Century Notebooking initiative, while others were found and selected for their prolific contributions to paper electronics on social media channels like Twitter and the 21<sup>st</sup> Century Notebooking online community and through book resource publications. One of the educators is a collaborator who runs a pre-K program in Singapore while the rest of the educators are based in the United States.

Through this qualitative investigation I gained insights from educators who worked with learners in natural learning settings through authentic processes so that paper electronics would be evaluated in all the complexity and diversity of natural learning environments outside the lab setting. The remainder of this chapter shares my research methods, analysis of documentation by educators and educator's reflections on their experience with paper electronics as a teaching tool. I conclude with a summary of my lessons learned for designing accessible construction mediums for educators and learners.

## **CONVERSATIONS WITH EDUCATORS**

My goal in the educator interviews was to learn about each educator's background, their learning setting's resources and constraints, their process for using paper electronics, what they hoped to accomplish and how the medium has worked or not worked for them. I conducted these interviews over a period of two months over the phone and through online chat clients. Each interview was semi-structured and lasted approximately 60 to 90 minutes. My questions were divided into the following themes with example questions:

### 1. Background

*What is your position and experience in education?*

*What grades/subjects do you teach?*

*What experience do you hope to create for your students?*

### 2. Experience with paper electronics

*How did you find out about paper circuits?*

*What activities have you done with your students?*

*What resources have you used/created to facilitate?*

*How long have you been teaching paper electronics?*

*Has how/what you've taught changed over this period?*

### 3. Reflections

*What is most exciting for you? Your students?*

*What is most frustrating for you? Your students?*

*How is paper electronics different from your other activities?*

*Why do you choose to use/not use it in your learning setting?*

### 4. Future

*What do you hope to do next with paper circuitry?*

*Do you have any requests or suggestions for the circuit stickers toolkit?*

Table 1 presents the demographic background and experience of the educators including interview alias, gender, position as educator, years in that position, learning setting, technical background, how they found out about paper circuitry and how long they have been using it as educators. Learning setting refers to formal settings like schools and universities versus informal settings like museums, libraries and makerspaces. Technical background refers to whether their knowledge of electronics comes from having a technical degree or whether they were self-taught. It is interesting to note that though paper electronics is very technical in nature, and that all of the educators interviewed have worked extensively with it in their learning settings, only 15% of these lead adopters have a formal technical background.

In how the educators first found paper circuits, HYN refers to the Hack Your Notebook initiative (described in *Chapter 3: Paper Electronics, Chibitronics section*); MIT Media Lab refers to workshops I've taught and documentation from the High-Low Tech research group; Crowdsupply refers to our crowd funding campaign for Chibitronics; Instructables refers to an outreach event where we gave free circuit stickers supplies to makerspaces around the world through Instructables; and Chibitronics refers to finding out about paper electronics through the Chibitronics website.

**Table 1. Demographic background and experience of interviewed educators**

Name*	Gender	Position	Years	Learning Setting	Technical background	Found paper circuits through	Years w/ paper circuits
Anthony	M	Pre-k program director	5+	Formal	Formal	Chibi-tronics	2
Barbara	F	Author and teacher educator	8+	Informal	Informal	MIT Media Lab	1.5
Caleb	M	Middle school English teacher	5	Formal	Informal	HYN	2
Camila	F	Arts educator	17+	Both	Informal	MIT Media Lab	2
Daniel	M	Former physics teacher/ College faculty	25	Informal	Formal	MIT Media Lab	1
Emily	F	Makerspace educator	1	Informal	Informal	Crowd-supply	1
Emma	F	Librarian and Makerspace educator	10+	Informal	Informal	HYN	2
James	M	Teacher educator and Author	10+	Formal	Informal	Crowd-supply	2.5



**Table 1. Continued**

Jane	F	High school STEM teacher/ College faculty	5	Formal	Informal	MIT Media Lab	5
Julie	F	Teacher educator/former humanities teacher	5+	Both	Informal	HYN	2
June	F	Makerspace educator	2	Informal	Informal	Instruct-ables	1
Lucas	M	High school English teacher	15+	Formal	Informal	HYN	3
Martin	M	Teacher educator	15+	Both	Informal	MIT Media Lab	5
Natalie	F	Teacher educator	9	Formal	Informal	MIT Media Lab	1
Robert	M	Museum educator	6+	Informal	Informal	MIT Media Lab	4
Rosa	F	Museum educator	5+	Informal	Informal	MIT Media Lab	4
Sally	F	High school English teacher	16	Formal	Informal	HYN	3
Samantha	F	k-12 youth program director	13+	Informal	Informal	MIT Media Lab	5.5
Sara	F	Museum educator	3+	Informal	Informal	MIT Media Lab	3.5
Sophia	F	Author and teacher educator	17+	Formal	Formal	MIT Media Lab	2

\* Names are pseudonyms to protect the identity of the educators who were interviewed

Audio recordings of these interviewers were transcribed and individual statements were organized based on emergent themes from the combined interviews.

In the following sections, I share selected examples of resources and documentation created by these educators followed by results and analysis of these interviews to evaluate paper electronics as a learning and teaching tool. Educators' real names are used to properly credit the resources and documentation while interview excerpts are kept anonymous under pseudonyms.

## HOW ARE EDUCATORS USING PAPER ELECTRONICS?

To learn about how educators are applying paper electronics in learning settings, I looked at activities that educators did with their students, public documentation of their own learning process, and the tools, techniques and resources created along the way. This section highlights some example artifacts and trends that emerged.

### Learning activities

Educators have come up with a variety of activities that use paper electronics to not only teach electronics, but give it more meaning by connecting it to other skills and subjects. The following sample activities share some of these diverse applications. While these examples are not necessarily representative of all the ways paper electronics is being used by educators, they were selected for being some of the most common and to provide a starting point for discussion.

One of the most popular paper electronics activities, both in and out of the classroom, is making illuminated greeting cards. Shown in Figure 1 are a Valentine's Day<sup>21</sup> card from the Yukonstruct Makerspace and a Mother's Day card<sup>22</sup> created by a student of librarian Colleen Graves. Light-up cards may be so popular in part because they are one of the simplest projects one can make with paper—simply fold a paper in half to turn it into a card—and are wonderfully broad, covering any theme the creator wants.



**Figure 4.1. Light-up greeting cards made with paper circuitry. Valentine's Day card from Yukonstruct Makerspace (left) and Mother's Day card (center and right) from student of Colleen Graves. Circuit Sketchbook template is used to illuminate this card.**

This structure works well with paper circuitry because it naturally creates one layer for the circuitry and one layer for the decoration, so that learners can think about them independently. Often the image covers the circuit and only the lights shine through. This

<sup>21</sup> Yukonstruct. (2014). *Anglerfish Valentine*. <http://www.instructables.com/id/Anglerfish-Valentine/>

<sup>22</sup> Graves, C. (2016). *Paper Circuits for Mom – Chibitronics*. <https://colleengraves.org/2016/05/10/paper-circuits-for-mom-chibitronics/>

is especially common for beginners who have not yet begun using the circuitry itself in their visual designs, which takes more strategy and coordination to integrate the circuit material with the rest of the image.

The two-page structure also lets teachers scaffold circuit making by giving students a standard template, while still allowing them to fully personalize their projects by decorating the outside of the card. Figure 4.1 on the right shows an example that uses the parallel circuit template from the *Circuit Sticker Sketchbook*.

Cards may also be a popular activity because it is a common way to celebrate special individuals and special occasions. Holidays regularly give teachers inspiration and context for doing classroom activities. Students are motivated to participate because it gives meaning to what they create beyond the learning context into a social one. Samantha, an educator who runs a makerspace for teen youth, describes gift giving as a particularly strong motivator for her learners, especially those who may not typically be inspired to learn and create electronics:

There's an innate gift-giving thing in folks. They often want to make something for their mother, girlfriend, boyfriend, or best friend. These projects especially with lights and paper turn out to be very interesting. Some kids are classic 'engineers.' For kids who are not natural 'engineers,' they tend to persist and figure things out because they want to give them to somebody.

In addition to flat circuitry, educators are also moving paper circuitry off the page into three-dimensional and multimedia artifacts. For example, shown in Figure 4.2 are personalized 3D paper thrones<sup>23</sup> and a glowing superhero mask<sup>24</sup>, activities designed by art educators Corinne Takara. Other popular personalization activities include decorating the covers of notebooks and creating illuminated nametags.

These personalization-based projects motivate learners to experiment and construct with paper electronics by giving them an opportunity to share about themselves and embellish functional artifacts in a way that makes them more personally valuable. Since glowing lights are an unusual decoration that attracts special attention, it adds special value as a decorative medium, which further motivates learners to engage.

---

<sup>23</sup> Takara, C. (2014). *Paper Circuitry Throne*. <http://www.instructables.com/id/Paper-Circuitry-Throne/>

<sup>24</sup> Takara, C. (2016). *Light-up Superhero Mask*. <http://www.instructables.com/id/Light-Up-Super-Hero-Masks/>



**Figure 4.2. Self-expression and paper circuitry in 3D: personalized throne (left) and mask (right) projects designed by Corinne Takara.**

Looking at content, rather than form, we see a trend in educators blending paper circuitry with storytelling. For example, Figure 4.3 on the left shows an interactive, illuminated comic book from a workshop by the 21<sup>st</sup> Century Notebooking initiative<sup>25</sup>. On the right are scenes made with magazine collage and paper circuitry made during a workshop at the Tinkering Studio,<sup>26</sup> a part of the Exploratorium science museum devoted to learning through hands-on making. Storytelling with circuitry is a particularly good match because the dynamic interactivity of a circuit—for example the light turns on when you press the button—lends itself well to highlighting and conveying the action of stories.

In the comic book project, the learner first built a model figure to inspire the story, then planned out the narrative through a plot map and sketched out the layout of the comic before finally creating the illuminated book. With the circuit collages, as a context for creating the circuitry, creators would pick out inspiring images from a magazine and weave a narrative to connect the disparate images.

In both of these activities, learners exercise their creativity in designing and building their circuit as well as imagining a narrative to go with it. At the same time, they must learn the theory of how to creating functioning circuitry as well as the mechanics of crafting a coherent story. For some learners the open-ended activity of coming up with an idea for the narrative can be more challenging than the closed-ended task of creating a working circuit. As a result, in addition to using illumination for inspiring ideas, educators use activities like collaging with found materials or decorating base objects (Figure 4.2) to further scaffold the expressive aspect of the paper electronics project.

<sup>25</sup> Cole, D. (2016). *The Adventures of Bubbles - Storytelling with Paper Circuitry at Alt School Alamo, San Francisco*. <https://vimeo.com/162213829>

<sup>26</sup> Jenkins, R. (2015). *Paper Circuit Collages*. <http://tinkering.exploratorium.edu/2015/12/10/paper-circuit-collages>



Figure 4.3. Storytelling with paper circuitry through a comic book (left) and collages (right).

With support from the 21<sup>st</sup> Century Notebooking initiative, many educators who teach humanities classes, found ways to integrate circuitry into their English and writing classrooms to engage learners in writing, critical thinking and even literary analysis. Figure 4.4 shows examples of illuminated poetry<sup>27</sup> and using paper electronics to analyze *The Great Gatsby*, a classic novel by F. Scott Fitzgerald (Cantrill and Oh, 2016). For these educators, building circuitry is another way to express oneself and think by making marks on a page.

In the poetry activity, taught by middle school English teacher Kevin Hodgson, light becomes a metaphor to help inspire learners in writing poetry. In the same way that using magazine images helped some creators come up with their story, the hands on nature and clear success of a working circuit helped scaffold the poetry writing process. In the *Gatsby* analysis activity, taught by high school English teacher Molly Adams, light from LEDs became a literal and figurative lens through which to analyze the light and dark themes behind the novel.

Educators have found that for some students, beginning with a physical circuit-making activity helped get more students into an actively engaged mindset, which led to greater participation during the analysis and writing portion of the activity. It is possible that having a clear goal for the circuit-building portion of the activity—getting the light to glow—made the more ambiguous space of creative writing—what does a successful poem look like?—less intimidating for learners.

<sup>27</sup> Hodgson, K. (2014). *A Paper Circuitry Collage of Student Work*.  
<http://dogtrax.edublogs.org/2014/05/08/a-paper-circuitry-collage-of-student-work/>



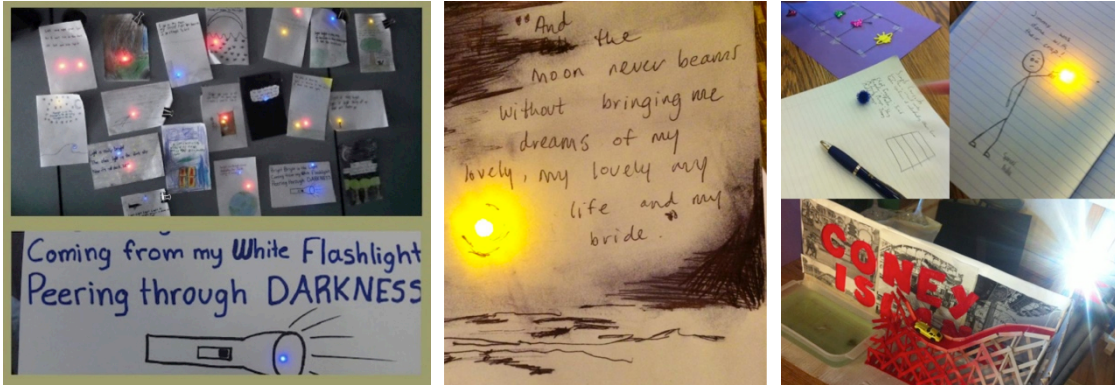

**Figure 4.4. Illuminated poetry classroom activity by students of Kevin Hodgson (left). Illuminated poetry example by Lou Buran (center). Using light metaphor and LED circuitry to analyze *The Great Gatsby* by students of Molly Adams (right).**

For these educators, working with the circuitry not only encouraged students to express themselves by creating physical artifacts, but also it nurtured their abilities to think critically and metaphorically, which were the ultimate goals of the writing activities. Lucas, a high school English teacher, commented that building circuitry itself can be considered as a form of writing:

It's more purposeful than just displaying the light. It's the same as writing, but instead of using letters the students are using circuitry to do the same critical or abstract thinking. They are making decisions about the circuit and those decisions are entirely their writing.

In other words, both paper circuitry and writing get students to externalize their thoughts onto a piece of paper in order to communicate ideas with themselves or an audience. Which ideas they convey are independent of the letters and the circuitry. Learners begin to think in terms of communication and interaction design. How will a reader interpret this text? How will a user interact with this project?

It is worth highlighting that though the activities presented above require building electronics, and therefore involve teaching learners how to design and build working circuits, it is applied through a diverse range of other disciplines—from self-expression through personalized superhero masks to narrative construction about giant ant attacks to narrative deconstruction with light metaphors.

While most traditional methods of teaching circuitry focus on only the circuit itself and how it works, educators are using paper electronics to take circuitry out of the abstract and apply it in many different contexts. As a result we see these activities being used not only in science museums, physics classes and makerspaces, which are designed with a

focus on technology, but also in English, art and humanities courses, which are not typical classrooms for teaching electronics. Educators are also using the expressive affordances of paper to give students the creative freedom to make their circuits unique and more personally meaningful. This diversity of contexts and creative freedom gives learners many pathways through which to become excited about learning and building technologies, engaging students who may not have otherwise thought such a medium was for them.

## Educators' notes

Because paper electronics is a new approach, many of the educators using this medium are learning it as well. By examining artifacts from their learning process, we see how making and documenting circuitry on paper offers new techniques for learning to create electronics. The following are some example circuit notebooks and sketches from these educators.

The first educator sketchbook is from a workshop held by the 21<sup>st</sup> Century Notebooking initiative to teach microcontroller programming. Megan Shaw, the creator of this notebook, had some experience building circuits with paper electronics but had not programmed microcontrollers before. Figure 4.5 shows how she documents her progress on the pages of a standard composition book.

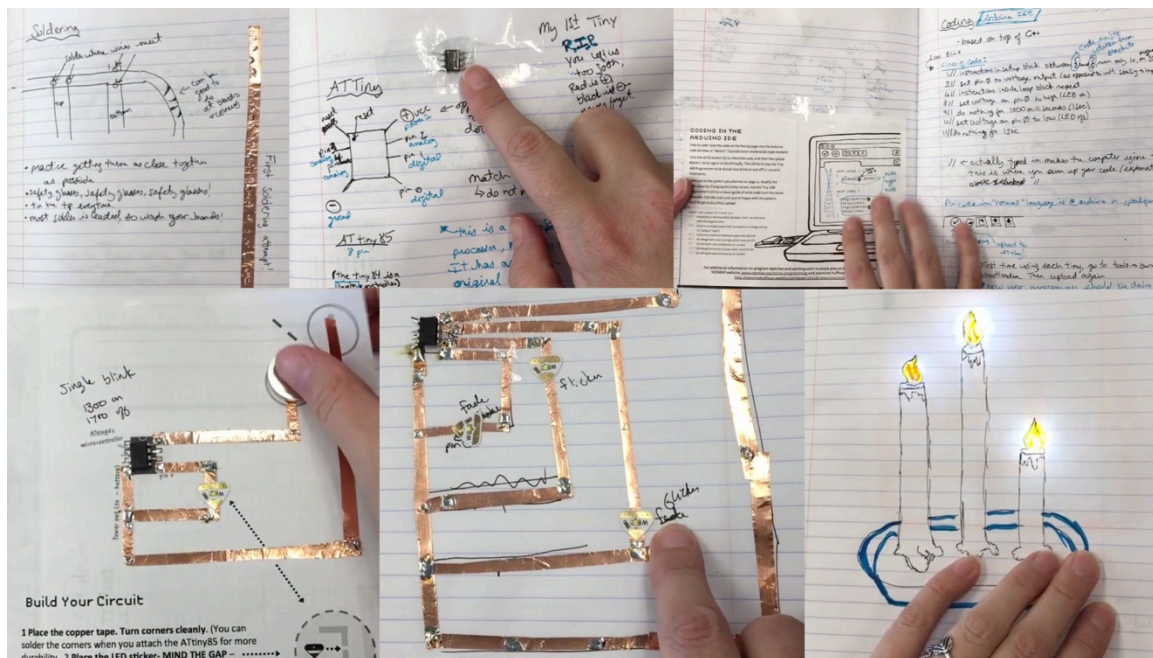

Figure 4.5. Educator sketchbook. Top: notes on soldering and introduction to coding. Bottom: microcontroller circuits and candle scene. (Notebook by Megan Shaw and images by David Cole)



She began by learning to solder on paper (upper left) and then in her excitement to begin, accidentally burned out a microcontroller by placing it in reverse on the programmer. She taped the broken microcontroller to the page as a reminder (upper middle). Then she took notes on the program before making an example circuit (upper right and lower left). Finally she designed her own microcontroller circuit and added an image of candles to complete the scene (lower middle and right). This example shows some unique affordances of paper electronics for learning circuitry: annotation, collaging and sequential documentation.

In each of the images, Shaw takes notes through diagrams and text right alongside the actual circuit artifact that the notes describe, such as like labeling LEDs and drawing a diagram of the copper tape to the actual soldered tape. Unlike with traditional circuit-building tools like breadboards, which offer only a grid of holes, or printed circuit boards, where components are generally packed closely together for cost purposes, paper offers both a surface that is made for marking and plenty of space to spread out the components to make room for text. Having the geometric flexibility to organize the circuit on a two-dimensional surface helps learners categorize concepts visually and see all the connections diagrammed out—the circuit is also the schematic. Being able to collocate the notes with their functional counterparts reduces the confusion of referring back and forth between the functioning circuit and the written notes.

This example also shows a scrapbooking approach to learning circuits, where many different materials are collaged together—the circuitry, old parts and handouts from the workshop—to collect and exhibit different kinds of knowledge in one space. For example, the strip of copper tape on the side of the page provides both a space for her to practice soldering, as well as show what different kinds of solder marks look like. The broken microcontroller is kept as a souvenir and reminder of how important it is to ensure correct polarity. Portions of handouts are pasted directly in the notebook for archival. Finally, the finished circuits provide a functioning example for her to refer back to. All of these techniques are possible because the components are flat and can be stuck down with regular tape, except for the microcontroller, which is soldered down. The permanence of soldering brings drawbacks, discussed in the next section of this chapter.

The images in Figure 4.5 are stills from a video showing Shaw flipping through and explaining her learning process<sup>28</sup>. Not only are her experiences saved in one place, the notebook structure means all of her experiences are naturally archived in order, showing how her knowledge builds up. For example, Shaw needed to reprogram the functionality

---

<sup>28</sup> Advanced Paper Circuitry Workshop. (2016). <https://vimeo.com/170303320>

of an LED due to the properties of the microcontroller, so she crossed out the original LED label and wrote a new one. In code, fixing this mistake typically means replacing the original text with the correct version so there is often no trace of the error—unless the coder actively adds a comment in the program—to learn from.

About creating circuitry on notebooks, another educator shares,

I like having all my notes and circuits in one book. “It’s messy but it’s my brain.” I can write my questions down as I’m working. I’ve made all sorts of discoveries just playing and exploring. This is important for students to have as well. I also love flipping through it and having all my notes in one place. I like seeing the progression of my thinking in handwritten notes. I learned more having it in book form.

- Julie, teacher educator and former humanities teacher

It is important that adding electronic functionality to the page did not take away from the original affordances of a notebook. That is, with flat circuit stickers or surface mount components, learners could still do everything normally done on the page and the circuitry became just another type of making marks on the page.

Educators are also experimenting with and inventing new ways to represent circuitry on paper. The left of Figure 4.6 shows a circuit sketch by teacher educator and bookmaker Jill Dawson that color-codes different circuit traces to help clarify connections<sup>29</sup>. While circuits are normally sketched by abstracting the components into a schematic, which shows the component connections independent of physical layout of the components, this form of sketching allows the designer to design layout while still emphasizing how the components connect. The right of Figure 4.6 shows a blend of traditional schematics with the circuit sketch by overlaying a color-coded drawing of the circuit over the original, created by teacher educator and researcher Jeannine Huffman<sup>30</sup>. Yet another alternative would be to color the copper tape itself with permanent markers.

---

<sup>29</sup> Dawson, J. (2015). Alien Paper Circuit with Neopixels and Attiny85. <http://blingthebook.blogspot.com/2015/12/alien-paper-circuit-with-neopixels.html>

<sup>30</sup> Huffman, J. (2015). 21<sup>st</sup> Century Notebooking. <https://plus.google.com/100313277651088288555/posts/RdzoJ2fgz2V>

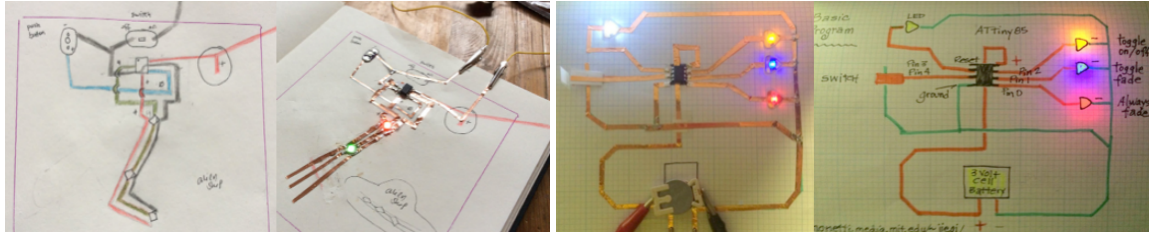

Figure 4.6. Color-coded circuit sketching by Jill Dawson (left). Functioning paper circuit with graphical overlay by Jeannine Huffman (right).

The ability to make graphical representations out of circuits is a powerful tool for making comparisons and connecting concepts, shown in Figure 4.7. On the left is a circuit that shows the effect LED color and resistance on brightness<sup>31</sup>. Each color has its own row and Dawson places resistors in the left column and LEDs on the right for easy comparison between colors. By using copper tape as lines, the circuit doubles as a graph. While most circuit topologies do not translate so easily into graphs, learners do have the freedom to arrange their circuits and components on the page in ways that support comparison and interpretation. The right of Figure 4.7 shows a comparison between a standard circuit schematic (in pencil on the left) and the actual functional circuit<sup>32</sup> created by former physics teacher David Peins. The components are arranged the same as they are in the schematic, making it easier to read between the two and helping convey that the schematic is a symbolic representation of the physical circuit.

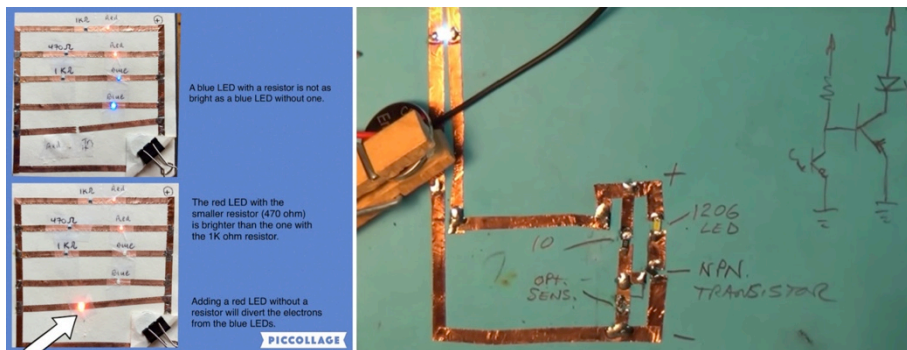

Figure 4.7. Circuit as graph by Jill Dawson (left) and standard schematic translated into paper circuit by David Peins (right)

Finally, the ability to craft custom circuits provides not only new ways for looking at circuitry but also for new ways to explore the relationship between circuitry and code.

<sup>31</sup> Dawson, J. (2016). *Resistors*. <http://blingthebook.blogspot.com/2016/03/resistors.html>

<sup>32</sup> Peins, D. (2015). *First Paper Circuit*. <https://www.youtube.com/watch?v=SSmzYOa8is8>

The example circuits<sup>33</sup> in figure 4.8 shows how a circuit, as well as code, can be translated and recycled to produce new projects.

Ryan Jenkins, an educator from the Tinkering Studio, created a bar graph paper circuit where each bar is turned on by pressing a switch (left). It can also be connected to a microcontroller, so the bars are controlled by code instead (center). Jenkins programmed the circuit to light up in response to music, making a responsive graph of the sound. This translation explores the power of programming to control circuits automatically and with respect to electronic signals, in place of the hand.

Jenkins goes on to create another circuit to be controlled by the same code (right). While the code and components are the same, so the circuit still responds to music, the circuitry is laid out in an abstract manner so that it no longer graphs sound and plays a light show instead. Finally, Jenkins makes an overlay of star-shaped windows to place over the LEDs, creating starbursts when the lights illuminate. This example shows how with the same code instructions but different circuit layouts, one can create a wide variety of artifact outcomes. The material and geometric flexibility of paper electronics affords this sort of conversation between creating with circuitry, code and craft materials.

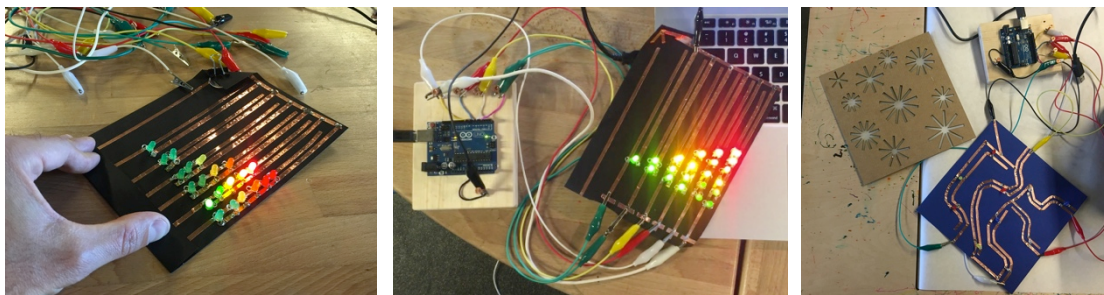

**Figure 4.8. Reusing circuitry and code. Paper circuit controlled manually (left) and with code (center). Reusing code with a new circuit (right). Images from the Tinkering Studio**

With so many ways to present and represent circuits on paper, these examples show how simply having the geometric freedom to “draw” a circuit on paper and in notebooks gives learners many more methods to organize, annotate, translate and revisit their circuit learning process than with traditional electronics learning tools.

---

<sup>33</sup> Jenkins, R. (2016). *Scratch Paper Sound Experiments*.  
<http://tinkering.exploratorium.edu/2016/07/20/scratch-paper-sound-experiments>

## Resources & Tools

The open and accessible nature of paper, as well as the culture of openness in the paper electronics community, has led to many new resources and inventions being created and shared by educators to make paper electronics more accessible. This section highlights some examples, which include circuit templates and handouts, custom tools and novel applications of existing materials.

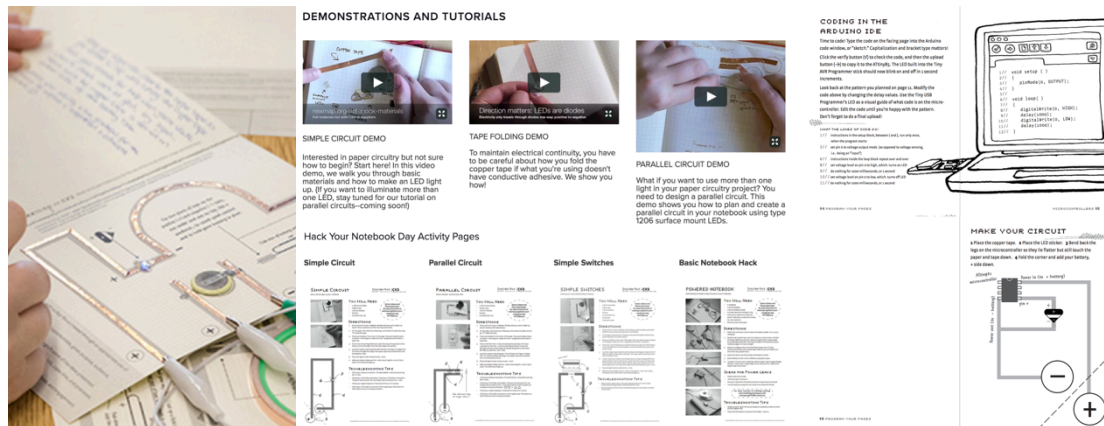

Figure 4.9. Circuit template and online resources from 21<sup>st</sup> Century Notebooking initiative

In Figure 4.9 are examples resources by the 21<sup>st</sup> Century Notebooking initiative<sup>34</sup>. The left shows a custom circuit template that remixes the simple circuit from the *Circuit Sticker Sketchbook* that provides learners space to both practice curves and corners with copper tape while building their first circuit, play with conductivity with alligator clips, take notes and reflect by writing about their experience. The middle shows the range of free and open multimedia resources educators are creating, including video demos and templates for Hack Your Notebook Day (described in more detail in *Chapter 3: Paper Electronics, Chibitronics* section). Finally the right shows two spreads from the *Program Your Pages* mini activity book for introducing microcontroller programming. This book shows how educators are moving beyond the initial simple electronics activities of the *Circuit Sticker Sketchbook* to create templates for more introducing more advanced topics like programming, while adopting the same visual language of circuit templates.

In addition to creating new templates, shown in Figure 4.10 are examples of how educators are also creating new styles and symbols that add to the circuit template language. The template on the left for a personalized throne<sup>35</sup> combines the circuit template with a 3D paper model template, which blends circuit construction with physical construction and borrows the language of both. The template shown in the

<sup>34</sup> 21<sup>st</sup> Century Notebooking. (2016). <http://www.nexmap.org/21c-notebooking-io>

<sup>35</sup> Takara, C. (2014). *Paper Circuitry Throne*. <http://www.instructables.com/id/Paper-Circuitry-Throne/>



middle<sup>36</sup> has one portion for constructing the mechanical portion of a paper panda robot while the circuitry is presented in the form of a drawing separately, showing how for teaching more complex circuitry it makes sense to keep the circuit separate from the artifact itself. Finally the right shows an example template of different types of lines to clarify different traces in the circuit for learners (Graves, 2016). Graves, who designed this template, was inspired by the different line styles found in textile patterns and translated it for paper circuitry.

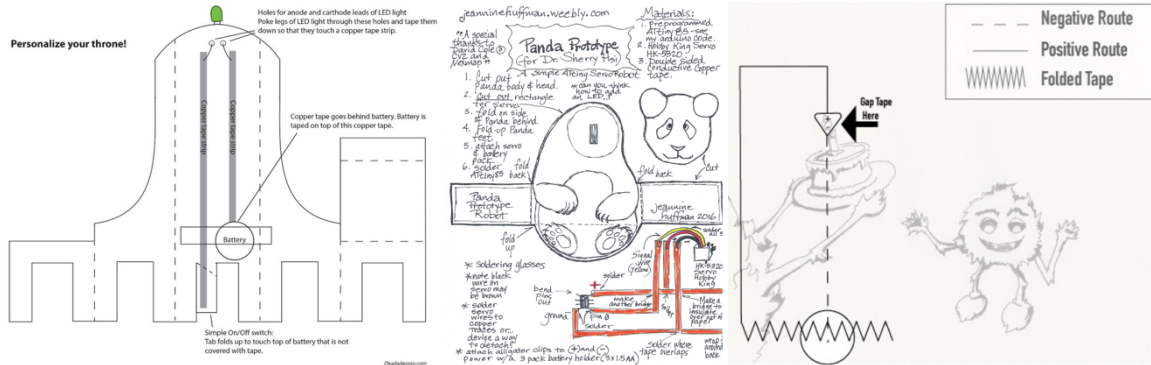

**Figure 4.10.** Circuit template for 3D personalized throne by Corinne Takara (left). Template and handout for panda paper robot by Jeannine Huffman (center). Circuit template with illustration and traces coded using line type by Colleen Graves (right).

Moving from resources to tools and techniques, Figure 4.11 shares some example inventions by educators to make paper electronics more accessible in terms of affordability, a big concern for many educators.

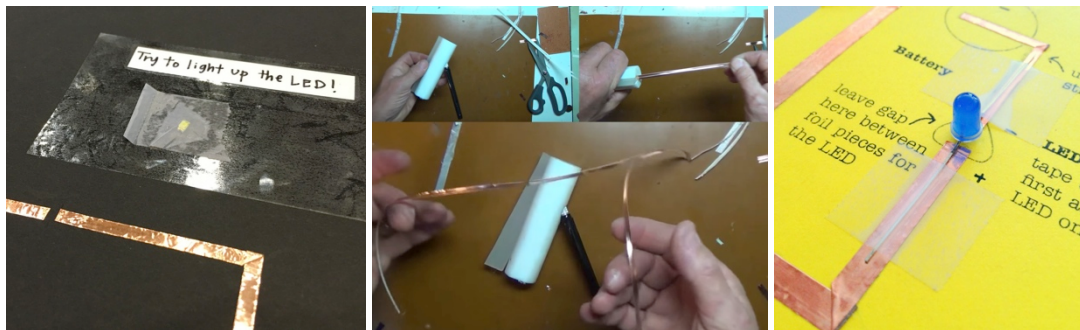

**Figure 4.11.** Circuit test board from the Tinkering Studio (left). Tool for cutting copper tape in half by David Peins (center). Using traditional LEDs with circuit template (right).

<sup>36</sup> Huffman, J. (2016). *Paper Circuit Resources*. <http://jeanninehuffman.weebly.com/paper-circuit-resources.html>

The left image shows a test board with a premade circuit<sup>37</sup> designed by the Tinkering Studio for learners to experiment with taping down an LED before making their own circuit, scaffolding the circuit design process and reducing waste from non-functioning circuit designs. It also uses the technique of putting down tape over the paper surface to make it easier to unstick from the surface. While the example shows taping down a surface mount LED, this technique is also useful for making a circuit sticker more reusable.

The center shows a custom jig for easily cutting copper tape in half<sup>38</sup> invented by David Peins, which doubles the length of copper tape that educators have to work. Another technique educators have used is to have students practice with painter's tape, which is both easier to work with and more affordable, before moving on to building circuits with copper tape.

Finally, on the right is an example of using a standard LED on a circuit sticker template. Another common material substitution is using aluminum foil rather than copper tape for making traces. While they may not have all the affordances of the copper tape and stickers, these more affordable materials still enable learners to create functioning and expressive circuits on paper, making it possible for more learners to enter the world of making electronics through paper craft.

## **WHAT EDUCATORS HAVE TO SAY**

Having examined some possibilities of paper electronics as a learning tool through the artifacts that teachers and students have created, let's now look at what educators said about these experiences. The following sections share insights from the educator interviews. I begin with an evaluation of the tools and materials of paper electronics, followed by an analysis of the learning processes and outcomes that educators observed. Finally I share how using this medium has led to new engagement from both students and educators.

### **Tools & Materials**

At the core of what defines paper electronics is its collection of paper-based craft materials and components. The following are some reflections on the benefits and challenges of using these materials for teaching, learning and creating with electronics.

---

<sup>37</sup> Jenkins, R. (2015). *Paper Circuit Collages*. <http://tinkering.exploratorium.edu/2015/12/10/paper-circuit-collages>

<sup>38</sup> Peins, D. (2015). *Splitting Tape*. <https://www.youtube.com/watch?v=H6Oy-2a7qOk>



### ***Material Accessibility***

Many educators noted that paper circuitry is uniquely accessible. It relies on materials that are relatively inexpensive and commercially available, so learners can feel free to play and experiment without worrying about wasting precious supplies. The materials themselves are simple and thus easy to understand conceptually. They are also safe and comfortably manipulated by hand, and thus easy to use physically. Especially with the help of templates, many learners can navigate paper circuitry on their own. Even if learners make mistakes, the materials are inexpensive and easy to replace. It takes advantage of learners' prior experience with paper craft, taking away some intimidation associated with the new and making it easier for learners to get started.

It's very relatable for younger children since a lot of what they're doing is crafts. Cutting paper or making a simple paper piece and just putting copper tape and treating it as a sticker.

Sara, museum educator

With paper circuits, it's okay for them to figure out on their own. With the right template and notebooks, it's easy to follow and figure out.

Emma, librarian and Makerspace educator

Paper is a very accessible medium. People don't feel bad wasting it. It's something people are used to and not worried about ruining it.

Sophia, teacher educator

One makerspace educator who works with youth educators found paper electronics, especially with circuit stickers, to be a popular prototyping and teaching tool for her youths. It is also quick since the components adhere instantly and function as soon as they're stuck in place.

When you need to quickly show someone how or you need to light up a project. Boom. Stick stick stick. Add a battery and it lights up. This is so much quicker and easier because you can pick them up and move them.

Samantha, youth program director

Accessibility means not just easy to use and understand for learners, it also means that the materials and tools must be available and affordable for educators. Unlike many other electronics toolkits, the medium of paper circuitry relies on integrating common materials where possible. The circuit stickers kit is designed to be as open as possible—so there are no custom connectors or special required modules—so that creators can easily

substitute parts and materials. This opens up the materials flexibility of the medium and makes it more affordable. For many educators, one of the biggest challenges is the cost of materials. The benefit of paper circuits is that paper itself is inexpensive and the pricey components have more affordable alternatives.

Cost is a big issue. When offering workshops, the materials budget is \$1-2 per child. To give students enough to do something fun can easily cost more. [Paper circuits] is still accessible because you can use aluminum foil tape. Give a foot-long piece and people can cut their own strips out of it. This is especially good for teaching 30 kids on no budget at all.

- Barbara, teacher educator and author

Materials are scrounged— there's not much funding. I order \$10 tubs of 500 LEDs from China and it takes 2 months to arrive but they work!

- Samantha, youth program director

Samantha refers to substituting more affordable standard bulb LEDs for circuit sticker components as one way to make paper electronics more economical. This shows that even though the circuit stickers toolkit is available outside of the lab to the public as a commercial product, reducing the cost to educators for this toolkit will make it more accessible from a logistics perspective.

One way to reduce cost is to make the materials more reusable. Unlike many standard electronic construction kits where parts can be fully reused, such as breadboards or littleBits (Bdeir & Ullrich, 2009), most paper circuitry activities consume materials since once the tape and stickers are stuck down, they can be difficult to peel back up without damaging the material. Every time a sticker or copper tape is peeled back, the adhesive loses some of its stickiness, which is important for electrical connectivity. Often times learners will peel back or re-use a sticker too many times and find themselves frustrated with unreliable circuit connections. This is especially common for beginners, who are more likely to make mistakes and need undo their circuits.

This permanence of paper circuitry takes away from the tinkerability of the medium and makes mistakes more expensive mentally. Since materials degrade every time the creator “undoes” a circuit, there is more pressure to create the circuit correctly and there is less freedom to explore the circuitry without producing an entirely new one.

As this research develops, one path for future work is to investigate is how to make paper circuitry tools that are affordable and robust enough for making permanent projects

while also being fully reusable to make the activity both more affordable and to enable greater tinkerability with the materials.

### ***Conceptual Simplicity***

Paper electronics is designed not only for material accessibility, but also simplicity and openness in order to make circuitry easier to read and comprehend. By relying on simple materials, basic units and keeping all parts of the circuit visible, the circuit is much easier for learners to read and dissect than with traditional electronics building tools.

I like paper [circuitry] because it boils everything down to a basic level. This is a battery, an LED, and something that delivers the power from the battery to the LED. There's nothing distracting... It's not just a diagram but a diagram that lights up.

- Barbara, teacher educator and author

In particular, educators have noticed the effectiveness of translating a circuit onto paper from breadboards:

When you see circuit on breadboard—students couldn't follow flow of electricity. [They were] just sticking in wires without following. When I translated to paper circuits it was much easier to understand.

- Jane, High school STEM teacher and college faculty

I taught copper tape and stickers first so they understood what is a circuit and how it works. I think it would be much harder to start with wire and breadboard first. It's more difficult to conceptualize... Because the wires are going over and up.

- Lucas, high school English teacher

The main challenge with traditional breadboard tools is that learners cannot see which connections are being made since connections are hidden beneath the board. It forces students to first conceptually understand and then remember which rows and columns of the board are connected. Even the plastic coating on breadboard wires, which are useful for preventing accidental connections as well as labeling, actually hide the conductive material from learners. The three-dimensionality of breadboard wires and the density of the grid add further visual complexity for learners to navigate.

Even educators who use a variety of conductive materials, rather than only breadboards, choose to start with paper circuitry as the introductory activity for teaching concepts before opening up to other conductive materials (Fields and Lee, 2016).

Tape makes it very visual. You must leave a space for the LED, battery goes on the circle, etc. It's good for teaching the concepts. Paper circuits is the gateway to learning circuits before using them in even more complicated ways.

- Emma, librarian and makerspace educator

While paper circuitry is often used for introductory activities, most educators and learners do not use it for more advanced circuit explorations. Is it possible that these materials are too simple?

Despite more advanced technical possibilities, teachers don't associate it with advanced activities. Teachers typically work with more complex circuitry in fabric or with the hummingbird robotics kit controlled with Arduino. They don't see circuit stickers as a way to bridge to bigger projects.

- Sophia, teacher educator and author

Even though there are circuit stickers with more advanced functionality, such as sensors and a programmable microcontroller, they are less frequently used. This may be due to the higher cost of the components, especially as they are consumable—once they are stuck down a few times they become less usable as stickers. At the same time, there are also fewer support resources that use these components and example projects for inspiration, which may have also resulted in less adoption. Finally, these advanced materials may simply not be as easy to use as alternatives like Arduino. For example, to program the microcontroller sticker, users would need to find an external programming board. For the paper electronics audience, many of whom are new to electronics, this may be too high a barrier to entry.

Outside of the circuit stickers kit, educators are also experimenting with advanced, for example programming ATtiny85 microcontrollers on paper. Such explorations, however, are less common. It may be that paper circuitry is simply associated with introductory activities while other mediums for electronics like Arduinos and breadboards are associated with more technically advanced functionality. As the medium matures, and novice paper electronics users become more proficient with the medium—and through it, electronics—I hope to see educators and learners naturally pursue more advanced technical explorations. At the same time, I will be designing more tools and creating more resources to support such exploration (see *Chapter 7: Paper Programming*).

### ***Material Expressiveness***

As a circuit building approach, paper electronics can integrate traditional materials like standard electronic components and processes like soldering on paper. Thus learners have access to the full breadth of circuit capabilities available with traditional circuit building processes. But what makes paper electronics powerful is that it can support these advanced technical capabilities while retaining all the material affordances of paper and its expressive connotations.

Paper circuitry opens up many expressive dimensions of electronics. Not only is paper a naturally expressive material but also the copper tape can be treated as functioning circuit connections as well as an artistic material for decoration. This allows both the paper and electronics to perform technical functions and independently contribute aesthetic form.

Paper is very artistic. There are different colors, weights, and you can paint and draw on it. Copper tape is really pretty and people get artistic with it. Having the dual idea that circuitry can be art is a big “ah ha” moment.

- Sophia, teacher educator and author

It fits in with what they're already familiar with: ribbon, construction paper, etc. It lends itself well to art and craft themed activities. There is a more exploratory, more expressive vocabulary.

- Camila, art educator

This expressiveness also engages different learners to create in different ways. Learners may start with the same materials and concepts, but end up with a wide variety of artifacts and lessons learned.

I like seeing people taking it into their own hands of what they find beautiful. Some might like to hide it in a pop-up or simple drawing so they put a cover sheet over, glue on and you never see [the circuit] again. Some people want part of the copper tape out so they cut a little hole, weave the copper tape so it shows and creates a path and then weaves back under the paper. It's a really unique thing that some want to show the electronics. A lot of people with other kinds of components want to hide but with this, you can creatively express with it as a material.

- Sara, museum educator

Finally, the versatility and many-dimensional applications of paper electronics offers learners from a variety of backgrounds and skill levels space to authentically engage.

When we do all-ages events, people of all levels of experience and knowledge can make something they are proud of. We see some people put a lot of thought into how to set up their paper craft to get the LED stickers to do what they want. But then some people with less experience are just happy to follow the instructions or an example to learn the basics.

- June, makerspace educator

There's a cool balance with more advanced people. You can still go into a paper circuit workshop, show them some complex examples like drawing with the circuit, and share that the circuit itself becomes art... It's a high ceiling.

- James, teacher educator and author

For these educators, who are often working with diverse groups of creators, such flexibility in a medium is important for creating a learning environment that is inviting and relevant to their diverse audiences.

Not only are the materials themselves open-ended, educators also have the flexibility to switch out one type of component for another type. The copper tape used in paper circuitry can connect to any type of component with exposed leads, and thus works across a variety of component types and electronics platforms. For example, in addition to sticking to circuit stickers, they can also adhere to the wire legs of standard components and solder to standard surface mount components and circuit boards. Aside from potentially reducing cost, discussed earlier in this section, this also gives educators the power to choose for themselves which materials and types of components are most appropriate for their learning environment.

Two museum educators use circuit stickers, standard bulb-shaped LEDs and small surface mount LEDs in their workshops and have found pros and cons to each.

Stickers help that you don't have to worry about colors and orientation is clear. A lot of people make the gap really wide but the gap is too wide. So instead of a tiny [surface mount] light, they use the larger sticker. Circuit stickers do take away a lot of bad frustration.

- Robert, museum educators

“Bad frustration” refers to frustration where learners struggle with a material due to lack of background information, rather than struggling on the way to building knowledge or figuring something out (explained further later in the *Learning through Visual Debugging* portion of this section). The circuit stickers are designed to clarify how they are used. For example, the arrow shape helps learners orient their LEDs in the right direction while on-board resistors help balance the voltage drop across LEDs, so that learners are not confused by the different voltage requirements of different colors. Their larger size makes the stickers easier to manipulate by hand, as well as enables larger tolerances for laying down traces. However, this pre-packaged design also adds a layer between the learner and the raw components.

I prefer using real surface mount LEDs because it feels more like creating from scratch. The material is more raw rather than a product, which someone already made for you. I like that rawness of material. Surface mount is also more accessible in that you don't have to buy this special thing. In intro workshops, to get across the idea of how a light works we will use [a bulb-shaped] LED as demo because they're so easy to see and easy to flip. Using these regular LEDs is good for younger audiences. I like to have all options available and give people the choice, though it can sometimes get overwhelming

- Rosa, museum educators

## Learning Processes and Outcomes

What is the experience of learning and creating with paper electronics? In the following section educators share some common learning processes as well as reflections on students' learning outcomes.

### That Magical Light bulb Moment

Over and over educators and learners alike describe the magical moment when someone turns on their first LED on paper. Cole calls this a “light bulb” moment<sup>39</sup> where a physical light is literally turning on and metaphorically an idea suddenly makes sense in a learner's mind. It's an exciting and pleasurable moment of success at that instills confidence in the learner to continue. But what makes it so powerful? For some, the magic comes from seeing simple materials behave in surprising ways.

There's something a little bit more magic. You feel like you're just putting a sticker down and it lights up! People don't expect paper. It's a drawing medium. It's something you have at home at school. You cut it,

---

<sup>39</sup> Cole, D. (2015). *21C Notebooking*. <http://www.slideshare.net/davidcole7359/21c-notebooking>



draw on it and crumple up and recycle. When it becomes the medium of a conductive project it's magical because people don't expect it.

- Camila, art educator

While learners can also build a light circuit by sticking an LED in a breadboard, there is power and delight in seeing familiar and normally inert materials like tape and stickers suddenly illuminate while still being a material they understand, can control and can create with. It challenges learners' expectations of what is possible for a material.

Perhaps more importantly, there is also the magic of learners surprising themselves with what they are capable of creating. Just as new possibilities emerge for the familiar and humble paper material, new possibilities for themselves as creators spring forth from this empowering moment.

It brings back the ability that 'hey I can do this!' It's not just the wonder over this little tiny sticker lighting up, that itself is magical. But there's also magic in "oh my gosh what else can I do? I understand this. I can do this. It's paper! There's so much I can do with paper!" So it's magical on those two levels... in the materials and discovery of this new thing but also there's wonder in "where else can my imagination go?"

- Camila, art educator

The halo of the light bulb moment extends beyond the original creator.

There's always the first one that gets it lit and everyone rushes over. Same thing happens with teachers where that first one inspires everyone else to kind of buckle down and try to figure out how.

- Caleb, middle school English teacher

The first circuit in the room to glow is often accompanied by gasps and cheer, and perhaps because the artifact itself shines, the light attracts the attention of those nearby like an inspiring beacon. If a peer can get the circuit to work, so can they.

### **Collaboration**

Almost half of the educators interviewed specifically noted how learners collaborated and helped each other more when creating with paper circuitry than with typical writing, crafting and engineering, in both formal and informal learning settings as well as between familiar peers and among strangers.

If I have students write something they won't share it or they won't ask someone for help with it. They won't say "will you read this, or what needs to change here? What can I fix here? Why isn't this

working?” With circuits they do immediately. As soon as they see their neighbor’s project working or light up they look over and ask, “how did you do that” or show me this and then they fix it themselves.

- Lucas, high school English teacher

One hypothesis is that familiarity of the paper and craft medium helps learners feel more equipped for the activity and less afraid to reach out to peers. When they do need help, they are looking for a specific bit of information rather than being completely lost and not knowing what to ask or being too embarrassed to ask. The increased collaboration may also come from knowing who to ask for help—neighbors who have glowing projects. However, the comfort in being able to ask in the first place may be due to the shared experience of everyone doing something new for the first time.

There were students who got it right away. Though I was going around, those students on their own were deputizing themselves to help others ... Part of that is classroom community and how the students get along with each other but I also saw that in all the teacher sessions too. There’s only so many people that one person [the facilitator] can help and so if you’re waiting and someone next you has figured it out, you will ask someone or someone next to you will help you out. I think that’s the power of something completely new. You’re all on the same starting line.

- Caleb, middle school English teacher

Especially for the first in the classroom to get their circuits working, it can be a doubly empowering experience as learners share their success by naturally taking on the role of teacher.

Paper circuitry projects also tend to foster collaboration due to the many different parts involved and the diverse types of expertise each one requires—the expressive idea, the physical construction, the aesthetic design and the circuitry. It is easy to break up into tasks for multiple collaborators. For example, often times a younger sibling might help with the drawing part of a project while an older sibling does the circuit building.

Often I got couples where the guy was an engineer and the girl was a crafter and there were gender normative roles. They would get to a point where each gets stuck and they could help each other. I enjoyed fostering that paired growing learning environment.

- Emily, makerspace educator

Accommodating varying expertise also makes for more interesting learning settings in groups, since it enables each learner to take advantage of his or her diverse interests and background to bring unique contributions to the group.

### **Learning through Visual Debugging**

Despite being simple, paper electronics is open ended enough for learners to make mistakes and create circuitry that does not work. While frustrating for the learner, many educators find the experience an integral part of learning to think critically and systematically as part of the debugging process.

I like when the circuit doesn't work because it forces people to retrace their work. Literally run finger back on circuit traces. It leads to interesting conversation on continuity and what's happening. And when it doesn't work, it's a rich troubleshooting experience that is very quickly rewarding because there's not much you can do wrong and it doesn't take a lot to get it right. I'm able to lead people with various skill sets through a circuitry project and expect 95% success. As an educator, being able to trust the tool to be reliable is important.

- James, teacher educator and author

The openness of paper circuitry materials helps make them accessible to debugging—the parts of the circuits are both visually laid out for inspection as well as physically accessible for probing and alteration. The simplicity of the materials also means there are fewer things that can go wrong and so debugging sessions are generally short and most likely lead to working circuits. This success is important for instilling learners with confidence to persist when they run into future challenges.

With little resistance to getting it to work. There is more willingness to take the risk to push oneself to next step and work through the anxiety around not understanding it.

- James, teacher educator and author

However, not all frustration is a positive experience. A museum educator reflects on his observations of good versus bad frustration with paper circuitry,

Good frustration is because it's hard and you're working on it or your striving to figure out your own goals versus bad frustration is where you're struggling with the material because it doesn't work right or the lighting is bad and you can't see what's going on.

However, I do think as facilitator I allow people to go farther down paths that I know won't work and rely on the fact that I can either cut things with the x-acto knife or solder them back together. But it's hard.

For example, someone will get very excited and try to make a tree with 10 lights. They start doing everything but haven't gotten the idea of just how one light works. It gets to point where you have to point out— pretty much all the things on this circuit need to change.

- Robert, museum educator

There is some tinkrability of paper circuit materials, especially with more advanced techniques likes soldering and desoldering or cutting connections with a knife, which allows facilitators to trust that learners will most likely have a successful debugging journey. Nonetheless, for some learners, they do need to restart a project from scratch. While this is frustrating, the relative low cost of the materials makes it reasonable to create more versions as part of the learning process, giving learners the chance to turn frustration from their earlier attempt into new and better iterations later on.

Paper electronics materials are easily manipulated as well as quick to work with—learners do not need to wait for materials to set or dry—so it's possible to make many iterations of a project in a short period of time.

Once you do one [circuit], you may not understand how it's working. When you make a second you start to really get it. Since paper is cheap, it allows you to do that second iteration. A huge part of the power of paper circuits is in its iterative possibilities”

- Camila, art educator

“We allow students to practice writing in many ways—you don't write once and are done—and with circuitry the idea must similarly sink in... Kids need time to play with the concept of circuitry. Often the activity is ‘it's a circle and you're done and move on’ but this doesn't give enough time to play around with concept of connectivity and the shape of the circuit. It's a tough concept ... If you don't play with circuitry, how will you get those instincts?

- Barbara, teacher educator and author

The result of “it's a circle and you're done and move on” style instruction is that students

often make a functioning model without truly understanding how it actually works. With multiple iterations, the extra time and extra practice gives learners room to play with an idea and test out its boundaries to more deeply and intuitively understand a concept.

Iteration is important not only for fully understanding an idea, but it also allows learners to practice and build upon their new knowledge. Each iteration gives them time to digest the new activity and take in the new concepts one at a time. Once learners do an activity many times, their creations also become more conceptually nuanced as they move beyond basic techniques and understanding the medium to actually applying it.

I got interested in having students build circuits to create artwork beyond ideas that seemed obvious. The first time students practiced actual circuits but they weren't using light as a brush stroke in their artwork. I learned that they have just to build a few circuits and all of sudden students were building more metaphorical works like a light at end of tunnel. I thought 'wow okay now you're really applying light for type of thinking.' By the third or fourth time, both the writing and circuitry became more abstract. Students started using it more personally for self-expression.

- Lucas, high school English teacher

Now that we have looked at some of the learning processes and types of experiences that learners have with paper circuitry, the remainder of this section shares some common learning outcomes that result.

### **Technical Competence**

Once learners are successfully engaged, what are they actually learning about circuitry? Educators used paper circuitry to introduce basic circuit concepts like connectivity, conductivity and polarity of components. The visual and open nature of these activities allow students to play around with the shape and topology of circuitry, gaining a deeper intuition for concepts like parallel versus series circuits.

When asked about learning electronics during an English class, one high school student responded, "I learned more about currents/electricity in this class than in any science class. I think it was the different approach" (Cantrill and Oh, 2016). The English educator who taught this student goes on to share,

My students truly felt that they learned better about circuits from me explaining it in laymen's terms rather than technical terms, than from their science teacher.

- Sally, high school English teacher

For these students, encountering electronics outside of the standard technology-focused classroom and presented in a new way helped them learn circuit concepts more deeply than experiencing it only in the traditional learning setting. Beyond circuitry theory, students are also learning to design and invent through this medium.

My goal is to teach the literacy of invention, of how things work.

[Students] have to learn that first before they learn to make their own thing. Part of it is materials literacy.

- Emma, librarian and makerspace educator

Materials literacy in this case involves both understanding the electrical concepts behind what makes the materials work as well as how to physically manipulate the materials and use the proper tools. For example, along with lessons on the theory of circuitry, many educators give learners lessons in folding copper tape or 3D paper construction. Another popular activity in both schools and informal settings is how to solder to copper tape on paper. As one museum educator explains, they prefer to teach visitors soldering because they “really value tool use” as a learning outcome.

However, paper circuitry does not take away the complexity of circuit theory itself. In many of these learning settings, we see activities teaching basic LED circuitry focused on how to get the circuit to work. However, more theoretical and quantitative concepts like voltage and resistance are left out of the lesson in favor of practical knowledge, like polarity and conductivity, which are necessary to create a working circuit.

Many educators have shared that as paper electronics evolves, they would like to include more theory and more math in the activities. A makerspace educator shares her concern that open-ended activities like paper circuitry may not teach concepts to level of depth and complexity as in traditional engineering classroom.

Engineering being taught lecture style is a very efficient way to dispense a lot of knowledge at once, so you see there's probably more depth in that.

It feels like current open-ended activities and kits and tutorials only scratch the surface. There's a trap of 'put an LED on it' and that's the end. And people don't go further. But doesn't have to be that way.

- Emily, makerspace educator

It is possible that such explorations of more advanced engineering can be taught using the paper electronics medium, but it just hasn't been done yet. For example, Daniel, a former

high school and college physics professor shared that he would like to translate example circuits from physics textbooks into paper electronics using copper tape and surface mount components. These would cover the advanced circuitry concepts typically taught in classrooms, but do so using the creative affordances and readability of paper circuitry. Given that the paper circuitry approach works with any standard surface mount component, it is possible to produce much more advanced circuitry than what we observe currently.

### **Expressive Confidence**

In addition to teaching electronics theory to new learners, paper electronics also allows them to creatively express themselves by making personalized, artistic creations. In many environments, the educators are just as concerned with nurturing learners' expressive skills through creation as they are in teaching technical concepts.

It's not just about learning the circuits but using technology in the service of telling stories, a way of enhancing the storytelling and not injecting storytelling so you can learn circuitry. I want them to use it as an imaginative tool... We're comfortable with this technology and know what it can do. How can we build in some of the values? Projects that will naturally tap the youth to either bond with each other, create community or improve their own communities?

- Samantha, youth program director

This approach encourages learners to see beyond the technical aspects of paper circuits to take ownership of the tool and apply it toward the bigger purpose of exploring and sharing their ideas on subjects that are meaningful to them, in ways that are unique to them, connecting with their peers and society as a whole. Another educator shares how paper circuitry can act as a bridge for youth who may not feel connected to the technology community.

We are in Silicon Valley but a lot of local children do not feel part of the technology conversation... they don't see engineering as something they can do. I'm trying to create opportunities for them to engage with the community through the vehicle of projects where technology and arts are blended. We need to create more opportunities for public feedback and these projects are ways to get real feedback. These simple circuitry projects are a way to get people grabbed. My goal to make it real world so models are not just for fun. It's self-expression toward a goal that is framed within their community.

- Emma, art educator

Paper electronics offers the blend of an expressive medium that is accessible to young learners and creators with the added functionality and attention catching nature of interactive electronic technologies. This offers many learners, who may otherwise not have a voice, a way to participate in the growing dialogue of technology as it affects them and their communities. Along with the guidance and public stage provided by educators like Emma, technology's ability to attract notice helps amplify learners' voice, enabling them to share their ideas more loudly with the community.

### **Putting it all Together**

By blending physical, conceptual, technical and expressive making, paper electronics gives educators a uniquely flexible medium to engage learners in critical thinking across disciplines, create connections and practice their ability to mentally coordinate these complex systems.

Paper circuitry activities blend knowledge from multiple subjects, giving learners the opportunity to integrate their learning from many different classes and see that though subjects may be separated in traditional school settings, they are actually interconnected and mutually enforce each other. For example, a 6<sup>th</sup> grade English teacher shares,

Though circuitry is part of 5th grade, 6<sup>th</sup> grade students connect back to science that they learned previous year and bring it forward. It shows in a way that writing isn't this isolated activity. That science isn't this isolated activity. Instead, that they can merge and inform each other.

- Caleb, middle school English teacher

Even though writing clear documentation in a laboratory class gives context to literacy skills through science and literary analysis is a systematic investigation of content in the humanities, these two domains are largely considered separate due to their being taught in separate classrooms. Blended activities like paper circuitry are taught in both settings, bringing engineering approaches like design, investigation and iteration to an English classroom as well as the artistic and expressive elements of technology to a science class.

More than covering topics from different school subjects, the making and complexity of paper electronics projects engages learners in many dimensions of critical thinking and design all in one activity. A student from Sally's English class shares,

I learned how to make a simple circuit. I learned craft vocabulary like 'apoxy.' I learned time management, the importance of planning ahead,



and following through with those plans. I also learned the importance of understanding metaphors, similes, and symbolism because it can make a difference in the ‘truth’ you see.

- student of Sally, high school English teacher

When learners engage with these paper electronics activities, their minds and hands are both actively understanding and creating the projects. The left and right brains are also engaged, thinking about both the technical means toward functional products and expressive meaning in what they make.

With so much happening all at once, it is worth investigating whether coordinating such processes help students learn or hinder how deeply the new concepts in each domain sink in. As this research matures, one avenue for further investigation is to give learners more time to create longer-term projects with the goal to see how they explore and engage more deeply in each of the plethora of technical, expressive, and creative choices and how this affects their development as learners and creators overall.

## **Engaging Learners and Educators**

Learning and creating with the materials of paper electronics engages learners and educators differently from traditional electronics tools. The following section shares some observations on how it has attracted new types of learners, as well as educators, to creating technologies as part of the learning process. It concludes with some ways in which such tools can be designed specifically to support educators.

### **New Learners**

All of the educators interviewed commented on how paper electronics enabled them to broaden their audience, engaging learners who may otherwise be intimidated or not interested in creating electronics. For many, these learners are attracted by the familiarity of paper and the fun of crafting.

It’s really widened my audience. I can get librarians who are somewhat mystified by Maker Movement to participate because it’s good old-fashioned paper. I can get young kids to participate because it’s crafting... When I pitch it as making holiday cards that shine, I instantly draw people in on the crafting level. Technology exists to make the magic happen.

- James, teacher educator and author

The beauty and arts and crafts materials of paper electronics has also been particularly successful in engaging girls and women to participate.

It was great for girls who love journaling. Middle school girls thought lighting up their notebooks was the coolest thing.

- Emma, librarian and makerspace educator

This librarian started a makerspace in her school library but found that initially only boys came in. With the goal of getting more girls to participate, she introduced paper electronics and found this to be successful. Another educator shares her experience at a public festival where she taught paper circuitry:

Boys had some interest too but as soon as I put out a strip of sparkly tape, you couldn't keep the moms and girls away. And we had grandmas and girls too. It was really nice to see this mother daughter partnership or grandmother granddaughter partnership.

- Natalie, teacher educator

This last example is particularly exciting as a demonstration of paper electronics inspiring technology creation in not only in women, but across diverse age groups as well. The tangibility and easily manipulated materials makes it possible for younger audiences, as young as preschoolers, to take part. Especially with these very young learners, the experience involves the support of older facilitators. This sets up opportunities for collaboration since even when the older facilitator is also new to creating circuitry, they understand how to work with paper and tape.

[Paper electronics] can get parents working with children because it's something parent's are okay looking like a fool in front of their child. It's much less intimidating. For example if a parent doesn't understand the first thing about electronics, he or she can at least fold card in half and start decorating while waiting for someone with more background to help. It's approachable— you aren't sitting around for an expert to tell you where to go. If you don't understand electronics, it's only one layer of what you're working on.

- James, teacher educators and author

Many educators have found the speed with which learners reach their first success, the “light bulb moment,” important in sustaining engagement. If a learner's first encounter with technology making does not provide them with enough facilitation for success and the learner feels lost, these learners (who are disproportionately female and minorities)

may leave the experience feeling frustrated and with even less self-esteem than before they began (Blikstein and Worsley 2016).

I love the light bulb moment for students or teachers in workshops, especially when they are or were like me – intimidated and then empowered. It makes me feel smart and powerful and accomplished and successful when I make the light light up. In fact, that is my FAVORITE part of every workshop – when people explain ‘Oh! I did it!’ I think doing this work is very empowering for girls and those not as confident about science.

- Sally, high school English teacher

Once learners reach this initial success, they have both the motivation of making more exciting circuit projects as well as the confidence to persist from have succeeded before.

### ***Educators as Learners as Educators***

A majority of the educators I interviewed learned electronics and programming on their own, rather than going through formal technical education. A few of them actually did so as a result of working with paper circuitry. Being a fellow learner allows these educators to better empathize with students, serve as role models and even participate as co-learners in the experience along with their students. Many educators took advantage of this in their teaching.

My students truly felt that they learned better about circuits from me, explaining it in laymen’s terms rather than technical terms, than from their science teacher. I love letting students be my “chief engineers” or facilitators of the work themselves and teaching each other what I cannot. I try not to be the most knowledgeable about it. I hope to have participants that want to help, challenge, or teach each other how to be better with this craft and skill.

- Sally, high school English teacher

As a fellow learner, this teacher had to restate concepts in a way that made sense to herself as a beginner, which allowed her to better communicate with her students who were also still learning the concepts. Not being led by an expert also enabled her students to authentically discover new things during the class and share with each other, taking ownership of the knowledge they’ve constructed for themselves. This teacher also shares,

I love ... how it makes me think, 'I teach English, so how in the world can I use this?' I love that it challenges me as a learner and as a teacher/facilitator. I want to learn more myself so I can be a better resource for troubleshooting rather than having to rely on others for that.

- Sally high school English teacher

By being genuinely challenged by the material as a learner, this teacher is also excited to learn. Her excitement spreads to the classroom through her passionate teaching as well as through her being a role model of the curious learner.

Many educators have found paper electronics to be a medium through which they discover their own interests for making electronics. Lucas, a high school English educator, shared his own development from not having made a circuit or programmed before to discovering paper electronics, learning about circuits and programming through it, and now using it as an important part of his teaching as well as his own creative work.

I remember asking about the difference between series and parallel lights and trying to understand voltage. It was dinner after I made a circuit for the first time... It was totally foreign to me. But that is something I could learn about. So I started messing around and I still mess around with my colleagues with electronics projects.

After sharing [the *Dandelion Painting* (see *Chapter 1: Introduction*)] at a teacher meeting at my school, a fellow math teacher did an interactive dandelion right away... I decided to create my own for a maker group exhibition. It was intense work, my biggest project, and I was very proud of it. It was really neat to talk about it and see people's reaction to the circuit itself. That was the heartbeat of the piece.

[This] work set me down a path I hadn't anticipated and really added a lot to my personal enjoyment and my career.

- Lucas, high school English teacher

Lucas currently teaches both an English course and a programming course at his high school. In both courses, students spend a week doing various writing and expressive paper circuitry activities.

Finally, another educator shares a story of inspiration where, as a bookmaker, she was

excited to see paper electronics bring a new dimension to a medium she already loved. This informed her explorations and translated into lessons for her students.

I ordered stickers right away and needed things to be even smaller for my personal projects so I moved into soldering surface mount LEDs. It was also my first time programming. I wanted to try an electret microphone and make a miniature dandelion prototype test...When I sat down and started playing around, there was steep learning curve. Eventually I got the Chibitronics microcontroller sticker to program and then a bare attiny85 microcontroller and I took off from there. As it drew me in, I would share with students. Not only was I fascinated, so were my students.

- Julie, teacher educator and former humanities teacher

For Sally, Lucas, Julie and many other educators, it is their own personal development as learners, inventors and creators that motivates and directs what they teach to students. Just as paper electronics has made building technology exciting and relevant to many new students, it has also engaged these new educators as learners as well, who in turn have been inspiring and sharing with more generations of students. This is especially unusual and exciting, since these educators—who all come from humanities backgrounds—are bringing science and engineering topics to students from outside the typical science classroom, and reaching new students and in new ways as a result.

## **REFLECTIONS & LESSONS LEARNED**

As a learning medium, the design paper electronics and the circuit stickers toolkit are inspired and guided by Seymour Papert's constructionist theory that the most powerful learning experiences are when learners actively engage in constructing physical artifacts that are personally meaningful, build upon their understanding of the world and have value in larger social contexts.

The expressive flexibility of paper electronics enables learners not only to create physically, but also create personally. We see this, for example, when learners make artifacts like a glowing Mother's day card, both a learning experience and a gift for something they care about. The goal to successfully create something worthwhile motivates their desire to engage deeply with the material and persist through debugging challenges. Making meaningful physical outcomes also makes the skills they learn in the more useful, as learners can see how to apply them in ways that matter.

According to Papert, “learning happens when we create ideas in our own mind, based on our own experiences and prior knowledge” (1980). Having some prior knowledge of a subject not only provides mental scaffolding to guide investigation and ultimately building a more complex understanding of the subject, it also sets up the space for surprise and wonder—that is, for existing knowledge to be disrupted. This is what makes paper circuitry so delightful for first-time learners, like the “light-bulb” moment, where paper and sticker materials behave in a surprising, illuminating way.

Similarly, more important than validating that learners’ understanding is correct is nurturing the confidence that their questions and ideas are worth pursuing (Duckworth 2006). With paper circuitry, this means intentionally allowing learners to go through “good frustration” by building circuits that do not work at first and providing tools and enough materials for debugging and making multiple iterations.

Through iterating learners have the opportunity to think critically and debug their project until it matches the desired goal and simultaneously debug their own understanding until it matches actual experience. In doing so, they practice the debugging—and learning—process itself (Papert, 1980). We all learn in different ways. Some individuals may prefer a “hard” (directed) approach while others may learn best through “soft” (indirect) exploration (Turkle and Papert, 1990). The level of challenge must match the interest and skill level of the learner—too difficult and the task is discouraging, too simple and it leaves the learner bored (Csikszentmihalyi, 1996).

Paper circuitry enables this approach by giving learners many pathways to engage, such as starting with building the circuit, drawing an image or coming up with the narrative behind their creation. At the same time, electronics novices can begin with templates while technology experts have the freedom to explore new and more advanced approaches like drawing with circuitry or incorporating more complex electronic components. These electronics experts may also take the opportunity to try out an art or craft medium that is new to them while keeping the technology simple.

To support such constructivist learning experiences for young learners, many researchers are designing construction kits. Resnick and Silverman present a set of design guidelines for creating these kits, such as simple units to foster creative construction, “low floor, wide walls” to support diverse explorations and learning styles at broad levels of complexity and making important ideas salient but not forced so that learners naturally encounter and acquire them (2005). In designing tools like the circuit stickers, I aimed to follow these design guidelines.

However, paper electronics as a whole extends beyond a single construction kit. Instead it is more of a *construction medium* defined more by physical characteristics rather than specific tools, components, or parts. It uses certain types of materials (e.g. paper and tape), tools that work with these materials (e.g. cutters, glue and solder) and electronic components that have matching physical attributes (flat stickers or surface mount components).

In the process of examining how learners and educators use paper electronics, I have found some strategies for designing such a construction medium for learners and educators with a focus on flexibility and accessibility. The following is a summary of these lessons learned:

- 1. Familiar and common materials:** Rather than creating custom modules or new materials, use familiar and common materials where possible. As with the untoolkit approach for electronics (Mellis et al., 2013), this also means that such materials will be more widely available, affordable and therefore accessible to more people. It also enables learners to take advantage of knowledge and experience they may already have as they learn new concepts. Furthermore, users may even have deeper intuitions for a material than the original construction medium designer, so users can become inventors of the medium as well.
- 2. Simple and limited palette:** Design for a simple and limited palette of materials and tools. Starting with a limited palette means less mental load for beginners to navigate so that they can quickly master the medium and move on to inventing and creating. However, design for each tool and material to have a wide variety of applications and properties and for them to be complementary. This way, complexity can arise from new combinations made with the limited palette without the confusion too many new parts.
- 3. Simple and few interactive functionalities:** To simplify the learning process, introduce a limited variety of interactive possibilities—like sensors and actuators—so that learners are not overwhelmed with functional possibilities and end up spending their energies only exploring the abstract functional aspects of the medium. With a limited set of interactions, learners can explore each option more deeply, playing with creating context and meaning around the interaction or translating interactions from one context or material to another.
- 4. Open palette:** Make sure that materials are physically interoperable with a wide variety of other materials—avoiding constraints like custom physical



connectors—so that the medium is able to work well with other mediums, or even be the connector between mediums that are normally not combined. This opens the creative possibilities should learners want to expand beyond the medium. Open also means to make sure materials have alternatives, so that learners and educators have more accessible, affordable options that fit their resources.

5. **Authentic materials:** By authentic materials, I mean those that are used outside of the learning environment by experts, as opposed to using “artificial” materials reserved for only beginners. This makes the skills and understanding that learners acquire valuable and socially relevant beyond the learning environment. It also makes it easier for learners to transfer their skills as they graduate onto more advanced techniques. A shared vocabulary of materials makes it easier for novices and experts to connect, which strengthens the community of users. Here the designer’s role is to create tools that scaffold the beginner’s learning process with the authentic material, while being mindful to design so that eventually the learner will not need these support tools.
6. **Make black boxes permeable:** While some level of black-boxing may be necessary to create basic units that are also easy for beginners to use, design so that these boxes can be safely and easily accessed should learners be curious to explore. Make them accessible down to an “authentic” level, to encourage learners to reach a level of understanding that is most valuable outside of the learning environment.
7. **Permanent and temporary construction options:** Enable learners to create both permanent as well as temporary connections so that they feel safe to tinker and make mistakes with the medium as they learn, play and iterate and also create durable objects to keep. More permanent final artifacts allow learners to invest more personal value in their creation—they are less likely to break or be taken apart for material—which leads to greater motivation during the creative process.
8. **Support embellishment:** Make it easy for learners to add personal touches and decorations to their creation so that projects can be easily personalized. This means making the material itself highly shapeable as well as providing additional supplies, like markers for drawing and decals, for decoration. Doing so gives the learner more ownership over the creation and makes it more personally relevant. This adds value to the final project as well as the skills they learned through engaging with the medium, motivating them to explore further.

- 9. Support the hand:** Offer a rich tactile and sensual experience that naturally invites learners to learn through direct engagement. Use materials that are easy to manipulate by hand so that beginners do not need to learn how to use tools first. When necessary, keep tools simple to reduce the layers of translation between the learner and the material. The more directly learners can manipulate the material by hand, the less room there is for physical and conceptual confusion. Fast feedback is also more likely to sustain the learner's attention. Finally, seeing the labor of the hand on the final artifact also makes it more personalized, which often makes it more meaningful.
- 10. Simple transition between physical and digital:** Simple and fluid transitions between physical and digital forms—such as between the artifact and the code—of the medium allows learners to more quickly iterate while also seeing both digital and physical forms as friendly materials to tinker with. Even for mediums that are mostly physical in nature, it is worth having a digital representation for documentation and sharing purposes.

# 5. Expression

Through paper electronics, I hope to blend the expressive flexibility of traditional art and craft materials with the interactive capabilities of electronics, so that creators can express themselves in ways that are not possible with traditional mediums. To explore its expressive possibilities and limitations, this chapter looks at what happens when skilled creators use paper electronics. My research questions are:

- How does paper electronics enable new modes of self-expression?
- Can paper electronics support a diversity of artists' approaches?
- Does paper electronics allow artists to express their desired messages through their own unique styles?

I was most interested to investigate how paper electronics might augment artists' creative practices. I wanted to see what new techniques and applications for paper electronics might emerge in the hands of these experts, who have deep material intuitions for various aspects of the medium—whether it's paper or electronics—as currently there are few individuals who are masters of the electronic and material aspects of this medium. Finally, I was curious to find out whether artists are able to create works that are meaningful and authentic to their style, or whether they were ultimately restricted by the combination of technical and material limitations that come with paper electronics.

To explore these questions, I invited creators to make original pieces that blended their existing creative practice with the paper electronics medium. The resulting pieces were exhibited at the MIT Media Lab and the MIT Wiesner Student Art Gallery in a collection called *Paper Curiosities* (summarized in Figure 5.1). The exhibition ran from April 8 to April 26, 2016. I also collected data through interviews and surveys to learn more about the artists' process for creating their works. The following sections share my research methods followed by an analysis of the exhibition and artist interviews. I conclude with thoughts on paper electronics as an evolving expressive medium.

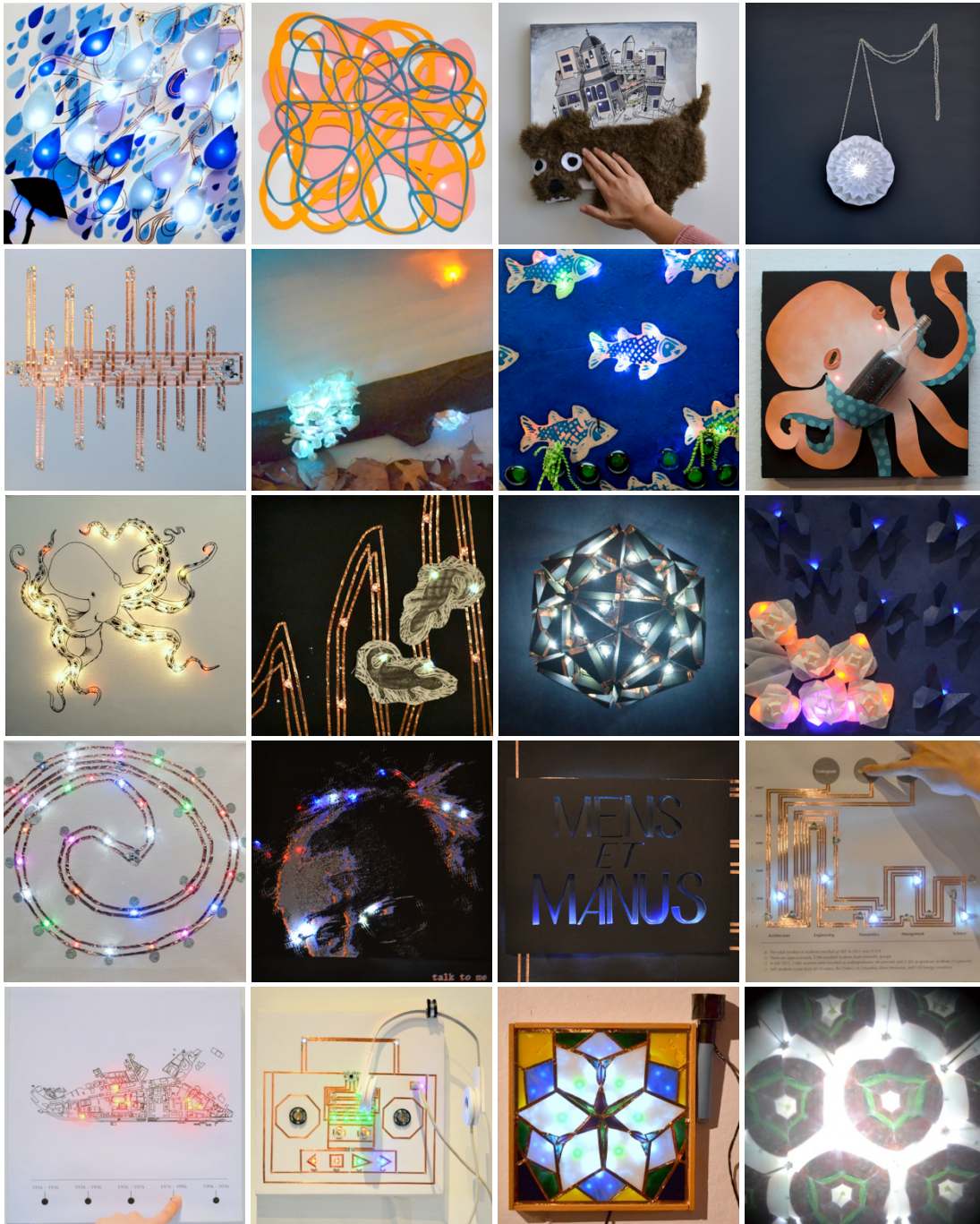

**Figure 5.1: Paper Curiosities artwork thumbnails and view through kaleidoscope in *Reflections* by Rahul and Emily Bhargava (lower right corner). See Appendix A: Paper Curiosities for titles, more images and artists' descriptions.**

## **PAPER CURIOSITIES EXHIBITION**

I began with case studies of six artists who each created an original piece with paper electronics. Participating artists all had an existing body of work that demonstrated a clearly established approach and style unique to the artists: a jewelry designer, children's book illustrator, electrical/computer engineer, bookbinder/book artist, paper cuttings artist and paper/textile multimedia artist (see *Appendix A: Paper Curiosities* for full biographies).

Each artist was invited to create a 12" by 12" square piece on canvas that blends the paper electronics medium with their existing creative practice. I gave them each a kit of parts consisting of one Circuit stickers starter kit, one pack of white, red/yellow/blue and tropical (pink, orange and green) LED sticker packs, one sensor and microcontroller pack, one effects sticker pack, a square canvas, USB cable and wall adapter and a set of alligator clips.

While everyone began with the same materials, each artist was encouraged to bring in their own tools, materials and methods. I decided to start with stickers-based electronics for getting people started, but artists were also encouraged to use standard circuit components if they desired. I provided technical assistance when requested, but otherwise artists explored and created on their own. Some artists publicly documented their design and building process through personal websites and social media. I also checked in with the artists twice through one-on-one interviews—first during the ideation and design phase and then again after the final works were submitted. The artworks were completed over a period of approximately one to three months.

Following the results from these six artist case studies, I wanted to explore a wider range of works. So, with the help of co-curators Katia Vega, Akshay Mohan and Xin Liu, I sent out a general call for participation to contribute artworks to the *Paper Curiosities* exhibition. We offered participating creators the same kit of supplies given to the original case study artists. We also held three weekly design and debugging sessions to provide support in case artists had technical questions or needed more supplies. After the exhibition, I sent a survey to learn about artists' experiences with paper electronics.

In total 16 undergraduate and graduates students from MIT and Harvard contributed 12 additional artworks to the collection. The group included five engineering undergraduate students, six science and engineering graduate students, three education graduate students and one law school graduate fellow. The pieces were created over a period of approximately one month.

Each piece is permanently documented and published on the exhibition website at [papercuriosities.media.mit.edu](http://papercuriosities.media.mit.edu) as well as catalogued in *Appendix A: Paper Curiosities*. Also included are abridged interviews and documentation from the six original artist case studies that share the concept and process for how each piece was created.

The breadth of artifacts, process documentation and reflections from artists of the *Paper Curiosities* exhibition provide much for evaluating paper electronics as an expressive medium. The remainder of this chapter shares my analysis around the materials, diversity of approaches and expressive flexibility of paper electronics.

## **MATERIALS ANALYSIS**

For paper electronics to be a truly new medium, the materials must enable artists to achieve new effects in their expressive works. The following are some themes that emerged with respect to the materials of this medium.

### **Computational composites**

Materials used to make paper electronics are generally flat, flexible and adhesive. As a result, they can be easily integrated directly into a variety of other materials. This creates a computational composite material (Vallgård and Redström, 2007) that takes on the properties of both the circuitry and the traditional craft “matrix” material. For instance, copper tape and circuit stickers can adhere to sheets of paper to create a composite material that is flexible, foldable and accepts ink marks but also retains the interactive properties of circuitry.

Such composite materials bring the interactive and computational possibilities of electronics into a physical form where it can be more easily manipulated by hand like traditional materials. Some artists took this approach when they embedded circuitry inside or on the surface of paper and then shaped this composite to create a 3D form. Examples include the light bracelet and Icosatrox geometric form (Figure 5.2).



**Figure 5.2: Light bracelet by Yael Friedman (left) and Icosatrox by Jonathan Bobrow (right)**



Novel composites also allow artists to give normally inert materials unexpected electronic properties, creating experiences of surprise and wonder. *Book in a (Paper) Box* features an image of a boom box made with functioning circuitry that also plays music through paper headphones (Figure 5.3). Listeners switch between paper-themed songs by pressing buttons on the boom box image. The image and paper headphones are not only visual representations but also working artifacts, adding poetic depth to this piece.

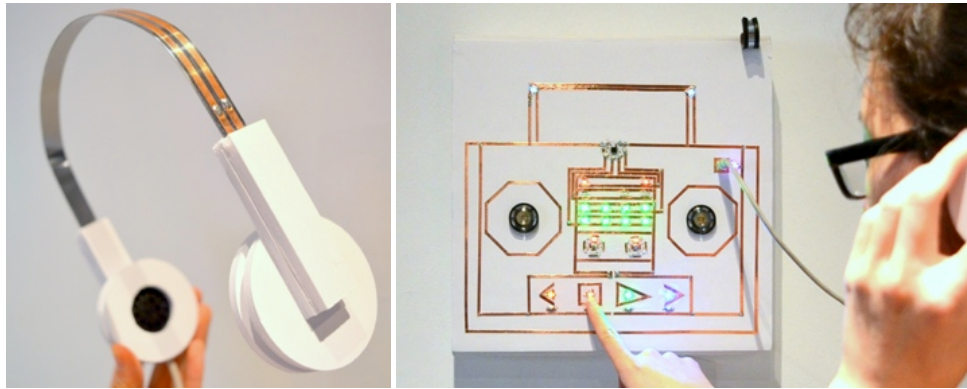

Figure 5.3: Boom in a (Paper) Box by Anthony Landek.

### Manipulating materials in the time dimension

Most traditional expressive mediums have a single final physical state as shaped by the creator. However by adding circuitry, even after the physical form is set, the material can be activated with electricity to have multiple states. This property allows creators to use time as an additional dimension in their expressive toolbox. While all materials change over time through the aging process, paper electronics materials are dynamic over time in reversible ways and at speeds that creators can control.

Having multiple states allows creators to hide and reveal information at different points in time, allowing the same physical artifact to tell many different stories. For example, in *Bernie*, the piece shows different patterns of light in Bernie's hair (Figure 5.4, top). With computation, electronics can also have a memory, allowing information to be saved for future use. In the case of *Bernie*, the piece shines different patterns depending on how many times you have spoken to the artwork, encouraging sustained audience interaction.

The time dimension enables sequential storytelling through a lo-fidelity version of animation. In *Quiet Invitation*, the artist turns on various lights in a sequence to tell the story of fireflies signaling for mates after the sunset. She changes the lighting from day, to dusk, to night and back to day (Figure 5.4, bottom) to express this temporal change. Traditionally a book artist, she described this new approach as “time/animation-based storytelling” rather than “page-turn based storytelling.”

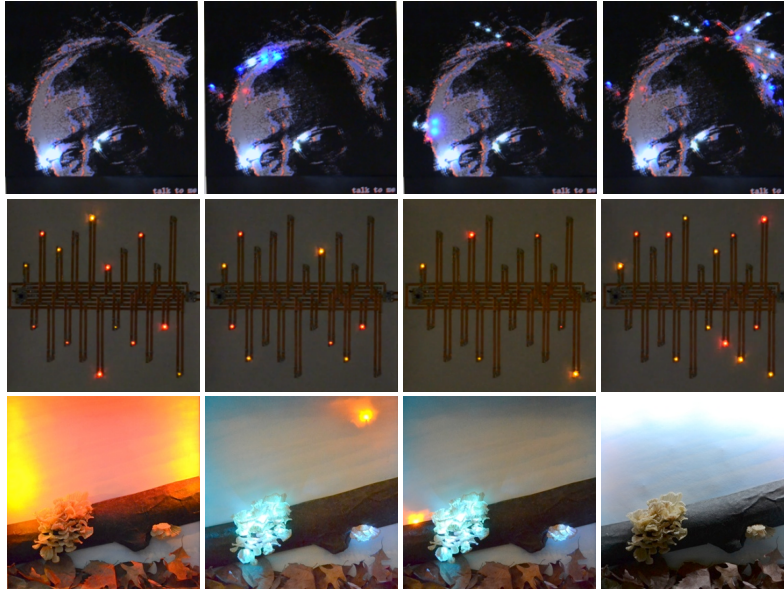

**Figure 5.4: Top row: animating light patterns in *Bernie* by Joy Yang. Middle row: random light flickering in *Frayed Bus* by Owen Trueblood. Bottom row: time-based storytelling of sunset, fireflies and sunrise in *Quiet Invitation* by Mary Uthupuru.**

Being able to manipulate materials in time also gives artists the expressive variables of speed and rhythm. For example, in *Bernie* and *Frayed Bus* (Figure 5.4, middle) the lights blink on and off suddenly, quickly and randomly to convey a high energy and frenetic message of nervous dynamism. In contrast, in *Quiet Invitation* light levels change very gradually with long pauses in between. This creates an almost meditative effect that invites viewers to observe with close attention to notice the delicate life in the piece.

### **Materials that come to life**

Not only can material changes be controlled with electricity, but also since it is an external energy source, materials can become dynamic without apparent stimulus from the environment. Since the flow of electricity is silent and invisible, artists can use it to create works that “come alive.”

One example is the motto fading in and out in *Pulse*—representing the metaphorical liveliness of the university. Another example is the flickering light patterns in *Illuminating the World*. The circuitry is physically arranged to look like a brain but the flickering also symbolizes information being transmitted in the technologically connected world. Finally, *Curiosity of Rain* uses a combination of flickering and pulsating lights to bring action to the raindrops in the illustrated scene. These are shown in Figure 5.4.





Figure 5.5: *Pulse* by Stacy Mo (left), *Illuminating the World* by Ayesha Dawood (center) and *Curiosity of Rain* by Becca Rose (right).

Automation does not have to be light. For example, one artist found light to be irrelevant to her work, which is about the movement of complex physical mechanisms. Her pieces are currently dynamic only when manipulated by hand. As a result of working with electronics, she became excited about using electricity to actuate these movements, to bring in a new dimension of liveliness to her work. While she has not created such an actuated piece yet, she is currently experimenting with mechanisms that use shape memory alloy actuation.

### Materials that interact

Computation and circuitry also enable materials to change states in response to dynamic environmental conditions. As a result, the pieces not only come to life, but also can respond to stimulus from the audience. This sets up a two-way communication between audience and artist where the pieces can both send and receive information.



Figure 5.6: *MIT Campus Enrollment* by Ani Liu, Jasmin Rubinovitz, Penny Web (left), *Blue* by Ema Kaminsky (center) and *Galaxsea* by Katherine Hashimoto (right).

Interactivity can come in the form of direct manipulation by the audience. In the *MIT Campus Development* and *Enrollment* pieces, when users press on the labels, they complete circuit to deliver power to LEDs, which illuminate to reveal data about MIT

(Figure 5.6, left). Interactions can also be programmed, so that viewer input goes beyond turning on the circuitry with on/off switches. For example in *Blue*, when viewers illuminate the sensor fish with their own light source, the rest of the fish illuminate as well (figure 5.6, center).

Finally, these pieces do not need to respond only to audiences, they will also change depending on the surrounding environment. For example, in *Galaxea* the octopus will blush when placed in any dark setting, though audience members can artificially activate this change by covering its light sensor (Figure 5.6, right).

Once materials are computationally augmented, they can also interface with the wider technological ecosystem. One artist mused about creating a piece that functions as a QR code for phones, incorporating live data from around the Internet into his artwork.

### Light as material

Many artists used the effect of light shining through materials to either emphasize portions of their piece or reveal new information hidden behind an otherwise opaque material. An artist described this as a new “interior” layer she could work with in addition to the normally flat images which have only the front and back. When the interior is activated, since light shines through multiple layers it changes the visual properties of surrounding layers.

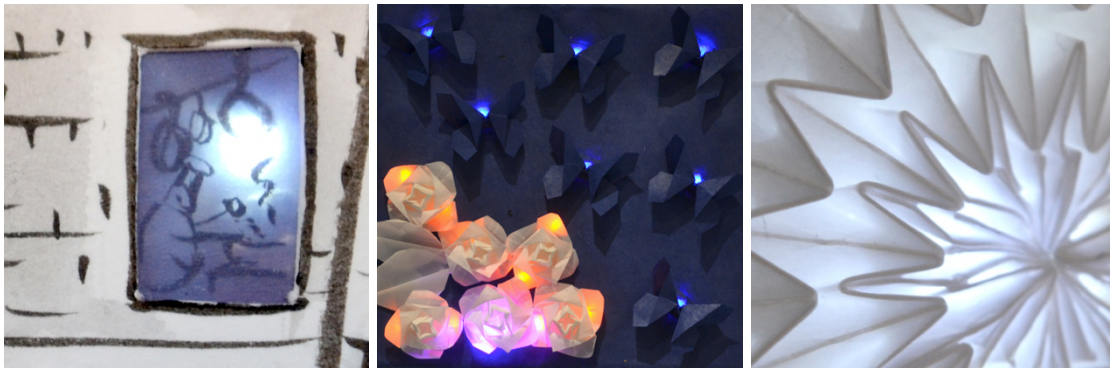

Figure 5.7: Backlit illustration from *Tickytown* by K-Fai Steele (left), highlighted butterflies from *Flower Fluorescence* by Alisa Ono (center) and illuminated folds from *Untitled* by Yael Friedman (right)

For example, one artist illuminated paper windows that revealed characters hiding below in *Tickytown* while illumination is used to bring out the butterflies that otherwise disappear into the background in *Flower Fluorescence* (Figure 5.7, left and center). Several artists also experimented with how when light shines through a material, it changes the visual properties that material. Friedman used the property that folds are less translucent than unfolded paper to emphasize creases in her origami form (Figure 5.7, right).

Moving beyond paper, Bhargava found the surprising optical phenomenon that even when using the same LED light, various colors of glass diffracted the light into different colors and shapes depending on the minerals embedded in the glass. Normally, stained glass is lit with natural light from the sun, so these different responses to light are only noticeable through the course of a day. However, since he was able to quickly control and change the artificial LED source, he discovered these new properties.

## Analysis

Whether the individual techniques presented above are only possible with paper electronics is debatable. However, the ability to accomplish the combination of all of these effects using one medium *is* a characteristic of paper electronics. Being able to do so with the sensory and aesthetic versatility of traditional craft materials is also unique to the medium. Perhaps even more importantly, a majority of artists described using techniques that are new to *them* in the process of creating for *Paper Curiosities*.

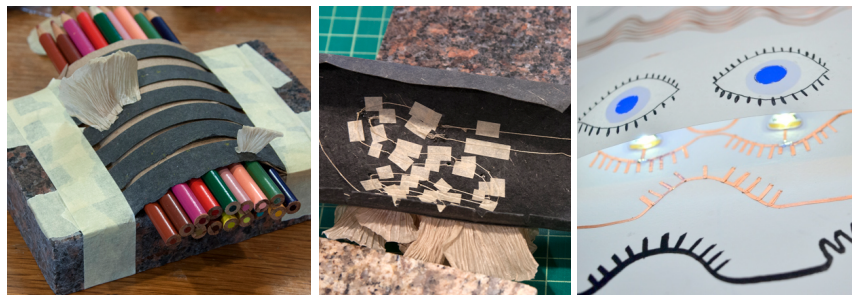

**Figure 5.8: Sculpture paper (left), securing conductive thread connections (center) and experiments with ink-drawn and copper tape lines (right).**

Mary Uthappuru described her process as inventing a new technique for every effect she wanted to create. This led her to try new experiments with sculpting paper that she had never done before as well as researching and inventing new ways to connect from one conductive material to the next (Figure 5.8, left and center).

Becca Rose had worked with copper tape before but had never used it in her own work for mark making. She found it interesting that copper tape “forces you to work in a slightly different way and make marks in a slightly different way because of how the material works.” The new types of marks made from copper then inspired her to try reinterpreting them in inks, furthering her exploration of both new and known mediums (Figure 5.8, right).

Finally, two of the artists were very familiar with building electronics but had not created technologies with an emphasis on the graphical presentation of circuit layouts. As a

result, they found their artworks satisfying in a very way different from their usual work. One artist described how being recognized for the way his work looked was new, surprising and fulfilling, especially as he had not considered himself very artistic, “can’t draw very well and [had] never done anything like this before.”

If artists had not explored traditional craft techniques with electronics in this new blended way, they would not have encountered these techniques and thus would not have applied them in their expressive work. As a result, paper electronics did in fact open modes of expression to these individuals and enabled the creation of new types of artifacts that would not have existed otherwise.

### **DIVERSITY IN APPROACH**

In order for paper electronics to be of practical use for personal expression, the process of using this medium must also fit artists’ workflow. By examining artists’ documentation and reflections of their typical creative process as well as how they created the pieces for *Paper Curiosities*, I found ways in which paper electronics supports diverse artists’ creative styles and how certain approaches seem better suited to this medium than others.

### **Incorporating existing styles of approach**

The six artists I invited for my artist case studies turned out to take vastly different approaches to creating their work.

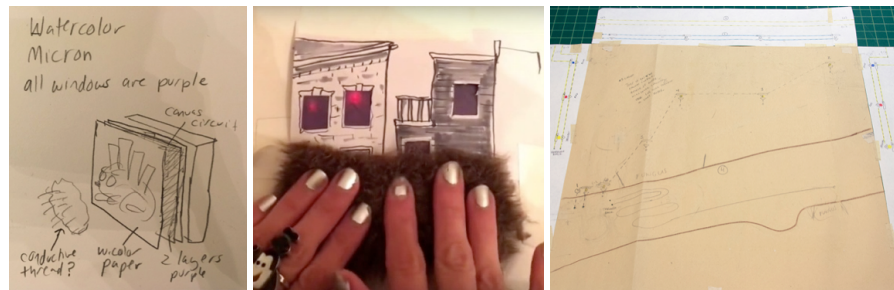

**Figure 5.9: Sketch (left) and prototype (center) for *Tickytown*. Circuit layout sketch for *Quiet Invitation* (right).**

Some had a clear concept and planned out their piece. In the case of *Tickytown* and *Quiet Invitation*, the artists began with a clear idea of the look and interaction of their final piece and went through a series of experiments to figure out how to achieve the desired effect. Their final designs were too complex to simply build in one go, so they also created simplified models and sketches along the way to help map out the circuitry and design the physical construction (Figure 5.9). For them, the main challenge was figuring out technical solutions to achieve desired effects.





Figure 5.10: Example spreads from Becca Rose's custom sketchbook.

Other artists preferred to start with materials experiments and let that determine the final concept. In fact, Friedman commented that for her, “once a sketch is down on paper, [the object] already exists” and she becomes less interested in actually making it. Instead, she preferred to prototype in her head and explore by making a series of fully functioning electronic and sculptural models. Rose found working on the final piece conceptually “intimidating” but enjoyed thinking through manipulating materials, especially by hand. So she made a custom sketchbook to provide a free space for experimenting with materials “without even thinking about the bigger idea” and was able to play with the materials without a particular plan in mind (Figure 5.10). For these artists, the process mainly was about coming up with a concept they were happy with.

Most artists felt more comfortable starting with familiar materials, a narrow set of design rules and prototyped largely in the physical domain. However, Trueblood explored many different types of digital simulations before settling on the final physical design. Even then, the design was a physical translation of a digitally projected image. For him, physical construction ended up being more challenging than anticipated. His process was a marathon of different digital to physical techniques (Figure 5.11).

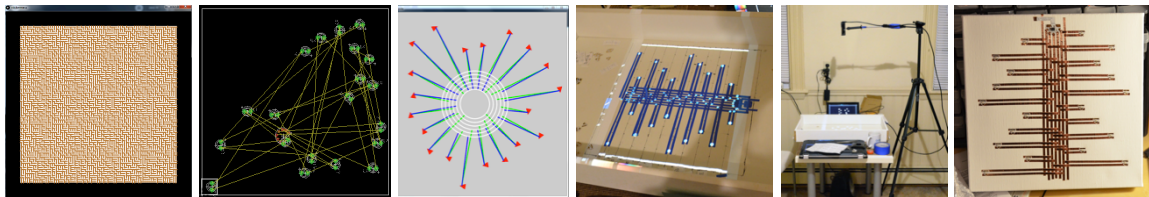

Figure 5.11: Computational design, projection mapping and hand-fabrication process for constructing *Frayed Bus* by Owen Trueblood.

While most artists went back and forth between aesthetic design and circuit design, and let the two processes inform each other, one artist separated the two and let the paper craft aspect completely determine the circuitry. Mallory created the entire paper artwork

top layer before building the LED circuitry to accompany the image. This piece also needed additional debugging on my part to get the circuitry into a functional form. This artist focused her process on the top layer because it clearly displayed evidence of the hard work that went into creating the piece and paid less attention to the circuitry underneath because evidence of effort on this layer is hidden from the audience.

### **Incorporating existing mastery of mediums**

Artists also demonstrated incorporating not only their existing workflows, but also aspects of their existing creative practice in paper electronics.

Some artists incorporated tools, materials and even expressive concepts from their existing work. For example Mary Uthupuru is a book artist whose work is about telling stories. Though she was not creating a book in the traditional sense, she still used animation to tell a linear narrative. She also used the same tools and materials—paper, board, bone folder and water—to sculpt the same paper she would use to create books, except in her piece they became three-dimensional sculptural forms. She chose a specific type of paper for their translucency, which worked best with the LED lights. Her existing mastery and intuition about the properties of paper allowed her to create such delicate forms that truly appear alive and organic (Figure 5.12).



**Figure 5.12: Paper mushrooms from *Quiet Invitation* by Mary Uthupuru**

Another artist valued how paper electronics enabled her to create something technologically straightforward, but she was able to take advantage of her storytelling and artistic skills to create something delightful and engaging for audiences. This artist ended up creating a complex and vibrant interactive cityscape that tells stories through its many illustrated scenes. She was also able to incorporate her own excitement around different materials—using fabrics, tapes, ink drawing and special papers.

Because paper electronics is about using materials that integrate well with other materials, electronic components in the kit are interoperable with other forms of components. As a result, when artists felt comfortable, they not only brought in their own craft tools and materials but also their own electronics materials and components as well.

For example two of the artist brought in standard Arduino boards, which have more computational capabilities than the stickers, when they needed access to more programming pins. Some artists used a blend of sticker LEDs for flat surfaces and traditional surface mount LEDs for tighter and three-dimensional applications of lights. Though all artists started out relying on conductive adhesive to connect stickers to their circuitry, most participants soldered their circuitry for greater durability in the final piece.

Through taking advantage of materials expertise that artists already have, there is a shorter “time to mastery.” These artists can focus on learning the electrical aspects, while the mechanical and material aspects are already well understood and well practiced. This familiarity also enables artists to use their deep existing intuition of materials to guide new explorations and invent new techniques that novices to the medium may be less likely to achieve.

### **Plasticity and tinkerability (and lack thereof)**

The creative process is often a conversation between the artists and their medium—artist are both constrained and inspired by the properties of their materials and tools. It is important, though, that with mastery of the medium artists must feel they have enough creative control to consciously will the material to their desired form and to be able to keep changing it until that is achieved. Thus, paper electronics as an expressive medium must have high plasticity and tinkerability. To this end, artists had mixed responses to paper electronics, especially with respect to the circuitry aspects.

While most participants either successfully hid or integrated the circuit making with the aesthetics of their piece, one artist found using electronic components to be more like working with a “ready-made” where one can only change the arrangement of indivisible units, or risk losing functionality. This artist was most comfortable working with raw paper material, which can be radically reshaped without losing its original properties, and felt restricted by the physical limitations of the circuitry. However, other participating artists found the black boxing of functionality into units—like the sensor and effects stickers—to simplify the making process by reducing the number of connections they needed to create themselves.

Electronic components not only need to be connected to power, they need to be connected in specific ways for the electricity to flow properly and for the circuit to work. One artist was not familiar with the particular connections required and so even though the final circuit was connected in a complete loop, the basic circuit, the power provided was not enough to illuminate all of the lights. Due to the additional layer of electrical energy flow in circuitry, the behaviors are less intuitive than inert materials, and thus there is often a greater conceptual learning curve. This also constrains how artists physically arrange their materials and may affect the aesthetic outcome as a result.

One of the major drawbacks with paper electronics—and with electronics in general—is that if connected incorrectly, certain components can be irreversibly damaged. This is especially important during the making process since loose materials that are moved during the making process may lead to accidental circuit connections. For this reason, we have mostly started artists off with safer lower power supplies like coin cell batteries and advise them to disconnect power while creating the circuitry.

However this leads to another issue that since electronic materials are only in their active form when powered, artists must constantly go back and forth between making and powering to actually see their pieces. This delay between forming and making and waiting to see the results was brought up as an issue by several artists, who would have preferred the material be consistently in its active form.

Similar to the power issue, many artists found connection issues to be a problem, especially when relying on mechanical connection like sticking. In this case, though the connections were sturdy when first created, they would often lift overnight, resulting in unreliable results the following day. This “living” aspect of the circuit also caused some annoyance—since the piece would lose the desired form over time—which is why many artists ultimately soldered their pieces permanently together.

That said, during the design and testing process, many artists liked being able to temporarily hold components physically and electronically in place with adhesive and quickly shift the components around by untaping or unsticking. The challenge was that the stickers would eventually lose their stickiness, making connections even less reliable. As a result, several artists were actually hesitant to use the stickers for much testing. Even though stickers that have lost their adhesive properties can be repeatedly soldered to and desoldered from the circuit for secure connections, soldering is a more involved process, which presents a challenge to true reversibility and affects artist’ abilities to physically tinker with and develop the piece.



## **Complexity in composites**

Although none of the artists described technical difficulties as a limiting factor to their expressive goals, they did admit that there was simply more to think about when needing to coordinate the electronic, mechanical, aesthetic and—for some—the interactive elements of their pieces. Within the composite medium, artists had both the technical possibilities as well as the physical constraints unique to the constituent materials.

Several artists were able to successfully experiment and update their designs as they went along, though even these artists said they would probably plan out their pieces more in the future to avoid running into technical challenges that required much more effort to navigate. For example in *Curiosity of Rain*, by organically drawing while simultaneously laying out the functional circuitry, the artist found herself dealing with “crazy un-debuggable circuitry” that resulted from this exploratory approach. However, designing the circuitry from the beginning in a more analytical approach may not have led to such expressive, drawing-like circuitry.

Likewise, one of the artists spent the majority of his time planning and designing the circuit and felt that in the future he would spend more time testing out physical materials, not having anticipated how much effort it would take to physically translate his designs from digital form. While the circuit design went smoothly, the physical construction was surprisingly challenging.

Overall, paper electronics is a hybrid craft medium offers many pathways for creators of diverse styles to engage, whether it's through “soft” means like exploring materials or through “hard” styles like analytical design (Buechley and Perner-Wilson, 2012). The blend also forces creators to confront the opposite modes of creating, for example through the challenge of debugging an organically built circuit or the practical work of implementing a theoretical design.

One unique aspect of working with electronics is that it is often very clear whether or not something is working: either the circuitry behaves as desired or (most of the time when there is an error) it does not do anything at all. As a result, this gives artists a very hard metric with which to measure success, which is very antithetical to some who have a more improvisational approach to discovering and executing their creative concepts.

## **Reflections**

Overall because of the physical material and handcrafted nature of paper electronics, this medium seems to work best for those with room for playing and testing in their approach. Perhaps in the same way that painters often step back from their image in the

process of painting, to see the entire piece, paper electronics artists need to pause in their making to power and test their pieces to see if a desired effect is achieved, that is, to see if it literally works.

Unlike in more traditional mediums, which are generally directly shapeable by the artist, paper electronics involves a level of understanding of the materials beyond their mechanical characteristics. They must learn how electricity reacts to the material, whether it is in terms of conductivity and connection or how to deliver power to a specific electronic component. This gap between the artist and being able to directly shape the material is even wider in the case of programming, where artist must know how to describe their desired behavior in a language that is understandable by the electronics—the code. As a result, paper electronics artists must be even more amenable to testing and modeling their ideas with physical prototypes to see that the materials—especially in circuitry and code—indeed behave as intended.

Finally, because the medium involves so many diverse systems, there is an element of coordination that must happen to assemble the final piece. Artists must be able to break down larger systems into smaller, digestible parts to ensure that each piece is able to function before tackling the whole construction. For many artists, this meant making smaller abstracted models and prototypes to test the circuitry as well as creating separate layers in their final piece to hold different functions (circuitry versus aesthetics). For others it meant being okay to let the look of the piece be partially determined by the circuitry and letting go of some aesthetic control. In the end, artists also needed to be able to assemble these component pieces back together harmoniously—this often meant making slight tweaks and adjustments along the way where various layers and pieces came together. As a result, those who took an iterative approach seemed to achieve the most success with the medium.

It is worth noting that technical constraints may not be the only reason an artist chooses not to use circuitry in their work. There may be conceptual limitations too. For example, Friedman specializes in jewelry making and found it difficult to justify using light. Though she had no problems learning the techniques and theory behind creating working circuit—in fact she created a wide variety of working prototypes—she shares that, “taking light and putting it in something is not something I will do, because I struggled to make sense of the combination.”

It is possible that if these artists used paper electronics more, they would hone in on the processes that work best for them, and perhaps not need to go through so much iteration and testing. Many of the artists answered that they would do certain things differently if

they were to create their pieces again, meaning there is enough flexibility in the medium itself to evolve as artists become more proficient.

Ultimately, as with any new medium, there is a required period of learning toward mastery and perhaps we are only seeing the beginnings of this in paper electronics. If these artists decide to work more in the paper electronics medium, we will likely see evolution in their approach and the results of what they create. Many of the perceived “limitations” of this medium might not be inherent in the tools and materials but are rather part of the learning process of the creators. As creators gain mastery over time, these limitations may disappear.

### **EXPRESSIVE FLEXIBILITY**

Even though all the pieces were created with size and form constraints—all the pieces had to be 12” squares, mostly flat and light enough to hang on a wall—the artworks of the *Paper Curiosities* exhibition demonstrate a broad range of subject matter and styles that is possible with paper electronics. For comparison, see Figure 5.1 which shows all of the pieces.

Artists covered diverse themes with a variety of expressive goals in mind. Some artists wanted to tell a story, like in *Tickytown* or *Quiet Invitation*, while others communicated data through interactive interfaces, like the enrollment graph and campus map of MIT. Artists also took a more ambiguous approach by embodying emotions through abstract visualization, like the excited swirling of *Twinkling Stars Inside Stomach* or the frenetic, jarring lines of *Frayed Bus*. Some pieces were very personal, such as the collegiate pride of *Pulse* and the political invitation of *Bernie*, where the artist expresses her own anxiety about the state of politics:

I hope this piece captures some of the bizarre, anxious energy from this election season. Light is a great symbol for hope, excitement, technology, and uphill struggles late into the night. Shout at Bernie. I’d recommend “feel the Bern” but please choose your words according to how you feel about him.

- Joy Yang

When viewers yell at the image, Bernie’s hair lights up in different patterns, diffusing tension into a playful experience. Similarly, *Boom in a (Paper) Box* and *Reflections* invite audiences to play with music and kaleidoscopic imagery by interacting with the pieces. While these pieces are playful and humorous, other pieces are more quiet and evoked

meditative moods like the gently glowing pendant in *Untitled* and the gradually changing light show in *Quiet Invitation*, which may hint at the diverse personalities and interests of the artists as well.

When asked if her piece accurately reflected her work, Mallory responded with, “yes, it looks like something I made.” Looking at the various pieces in the collection, each piece exhibits an aesthetic and style of construction that is unique to the artist. Even pieces that had similar themes were still clearly made by different creators, such as *Octopus* and *Galaxsea* (Figure 5.13). An octopus is the central figure in both pieces but one is drawn in ink while the other is a colorful, 3D collage that extends beyond the canvas. *Octopus* also uses light to highlight the tentacles of the illustration while *Galaxsea* uses light to breath life into a tiny universe inside a bottle as well as make the octopus blush.



**Figure 5.13: Pieces with similar themes and different aesthetics: *Octopus* by Christina Sun, Kiran Wattamwar (left) and *Galaxsea* by Katherin Hashimoto (center and right).**

Though the technology often informed the artists’ concepts, their concepts were not directly limited by it. In explaining their process, most artists shared how they needed to make a piece that was meaningful to them, beyond looking interesting or novel due to the new technologies. Three artists made pieces that are about technology itself, but even then, these were explorations of larger themes like noise in signal, communication and the role of music. Interestingly, all three of these pieces also completely exposed the circuit elements and used very little other materials to convey their message (Figure 5.14).



Figure 5.14: Pieces with technology as theme, as well as core medium: detail of *Frayed Bus* by Owen Trueblood (left), *Illuminating the World* by Ayesha Dawood (center) and *Boom in a (Paper) Box* by Anthony Landek (right).

Some artists began by thinking about their personal interests, as well as how this might be best conveyed through light, which was the standard electrical output in these pieces. For example one artist was personally interested in bioluminescence in nature and another was interested in the lives of characters in cityscapes. Both of them ultimately used light in a more literal sense in their scenes—as the biological light sources in a forest or as the light bulbs in windows of buildings.

Other artists conveyed messages that were entirely independent of technology but used light as a more symbolic device. For example *MIT Campus Development* and *MIT Enrollment Information* uses circuitry to highlight data about the university. In *Bernie*, light becomes symbol of hope during struggle. Finally, *Twinkling Stars inside Stomach* uses light to represent emotion and evoke more physical sensations in the body.

Though paper and circuitry were at the foundations, these artists also added such a broad variety of materials like fabrics, glass, metal, painting and drawing that the medium is simply too amorphous to define a message. Instead these materials were manipulated in service of communicating deeper and unique meanings shaped by the artist.

## DISCUSSION

*Paper Curiosities* artworks show both the breadth of processes and artifacts that different artists take and create with the paper electronics medium. Looking more deeply at what defines expression, according to Maeda and McGee (1994):

- **Media:** there is some external vessel that can hold the concept outside the expresser's mind, such as paper, clay, etc.

- **Tools:** there is some way to shape the media in a conscious manner, such as with one's bare hands, a paintbrush, etc.
- **Skills:** the expresser understands the physics and metaphysics of his media and tools, and his experience with them allows him to mold forms of superior craftsmanship. Through his experience he possesses a basic vocabulary by which he can express himself.
- **Concept:** there is something that the expresser wishes to express; most importantly, he has the will to express (this can include the to express no concept at all). The expresser has an imagination within which the concept is nurtured and brought to reality with technique, tools and media.

In the case of paper electronics, artists' concepts are physically translated through the materials of paper and physical craft as well as through the interactions enabled by electronics. The tools they use include those that shape paper, like scissors, glue and ink as well as tools for building circuitry, like soldering irons and programmers. However, paper electronics is also porous, so people brought tools and materials from other mediums like fabric, glass, wood and screws.

All the creators had at least a working knowledge of LED circuitry, and often a deeper intuition for some aspect of the paper electronics medium, whether it's paper craft, drawing, sculpture, circuitry or programming. This gave artists with diverse interests the flexibility to shape the medium and successfully make works that are authentic to their style and accurately express their artistic concepts. As such, paper electronics indeed functions as an expressive medium.

What makes paper electronics different from traditional craft media is the interactivity of electronics and computation. However, artists have historically and currently continue to create artworks with physical electronics. For example, artists like Jim Campbell, Bruce Nauman and Bruce Munro are well known for using electronics in the form of light into their work (Figure 5.15). These artists use various types of lights but make few modifications to the actual form—instead, they treat these electronics as readymade items which can be rearranged but retain their original aesthetic and form. As a result, all of these works retain a traditional technology aesthetic—e.g. rigid parts, cables and wires, and often grid-based arrangements. They also tend to be large installations, perhaps limited by the large size of the initial electronics parts.





Figure 5.15: *Scattered Light* by Jim Campbell (left), image by Patrick Kelly courtesy Northern Lights.mn. *Human/Need/Desire* by Bruce Nauman (center), image by Ed Schipul. *Field of Light* by Bruce Munro (right), image by John Lord.

Other artists have played more with the physical form of electronics. For example Sandy Smith uses old computers like building blocks to create active architectural structures (Figure 5.16, upper left). Other artists are taking the materials of electronics and creating sculptures out of them, though often destroying the electronic functionality of the components in the process. Examples include Leonardo Ulian’s *Technological Mandala* (Figure 5.16, upper right) and the animal sculptures from Honeywell advertisements<sup>40</sup> (Figure 5.16, lower left). Finally, though rare, a few artists like Jim Williams are able to break down electronics to its bare components and reconfigures them into a sculptural form, while maintaining electronic functionality (Figure 5.16, lower right).

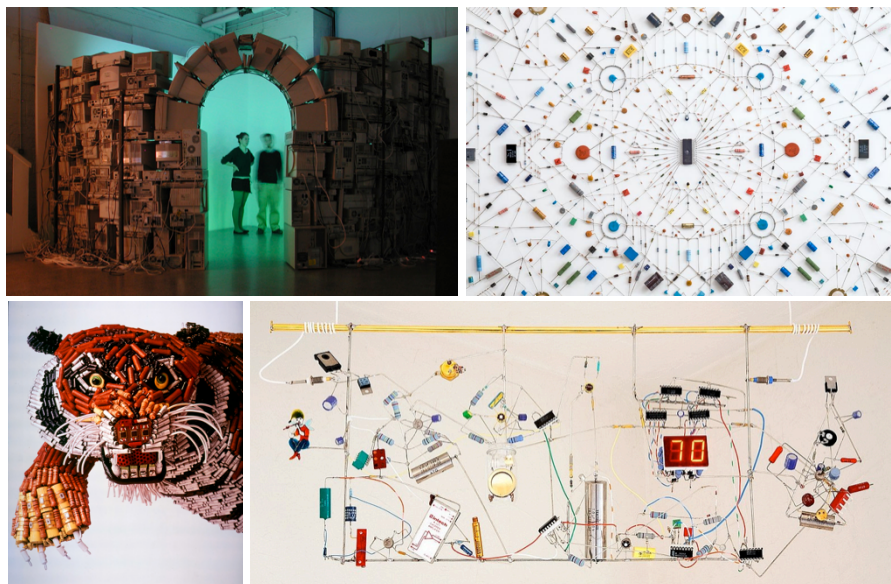

Figure 5.16: *Blue/Green Horizontal* by Sandy Smith (upper left). *Technological Mandala 02* by Leonardo Ulian (upper right). *Honeywell Thermometer* by Jim Williams (bottom), image courtesy Linear Technology.

<sup>40</sup> Spicer, D. (2012). “The Honeywell Animals. <http://www.computerhistory.org/atcm/honeywell-animals/>

While these explorations treat electronics more like sculptural materials, the physical limitations and electrical requirements of these types of components still result in a very clear technological aesthetic. Paper electronics differs from these more common approaches to making expressive electronics media because it offers creators much more freedom to shape the electronics material and integrate it with traditional craft materials.

The idea of using physical computational technology as an expressive material and medium has been explored by Maggie Orth, who defines several characteristics of such “sculptural and active computing materials” (2001):

- **Enable the simultaneous investigation of physical form and computation.** New sculptural and active computing materials must allow artists to simultaneously investigate physical form and computation. To do this, these materials must function simultaneously as physical design materials and active computing materials
- **Provide tactile, visual and mechanical variety.** New sculptural and active computing materials must offer designers and the people who experience computers a variety of tactile, visual and sensual experience... they must provide artists and designers with a variety of mechanical properties to choose from, such as stiffness, elasticity, strength, and softness.
- **Be directly shapeable or sculptable.** New sculptural and active computing materials must be shapeable so that designers and artists can create objects that physically reflect their artistic vision. They must provide designers and artists with immediacy so they can experiment and iterate with the physical properties of computational objects as quickly and easily as they can with software.

Orth approached designing such a computing material by using conductive threads and fibers to create soft interfaces to circuit boards, leading to what is now called the field of electronic textiles, or e-textiles. Figure 5.17, left, shows an example of a woven circuit textile. Since these early explorations, researchers like Buechley and Perner-Wilson have explored many other methods for traditional craft materials and processes can be used to create electronics with a focus on aesthetic diversity (Buechley and Perner-Wilson, 2012). Examples of carved, painted and sewn circuits are shown at the center and right of Figure 5.17. Paper electronics is one subset of these explorations.





**Figure 5.17: Woven color-changing e-textile by Maggie Orth (left). Carved, painted and sewn circuit by Leah Buechley and Hannah Perner-Wilson (center and right).**

My own focus on paper comes from its universality and ease-of-use. For many artists, even though they may end up using other mediums for their final project, sketches and prototypes are often made on paper because it is so easy to manipulate and inexpensive. At the same time, paper easily takes on diverse material properties—from rigid cardboard, to textile-like tissue, to translucent vellum. Similarly, materials like copper tape and stickers are easy to shape by hand, connect to both rigid and soft substrates as well as flat and three-dimensional forms and are relatively easy to work with since they stay in place with adhesive and hold their shape.

However, for me the paper electronics medium is less about privileging specific types of parts, or even materials, it's more about creating an accessible example for artists of how materials can be integrated with electronics in new ways and how electronics can have vastly different aesthetics and forms than what we traditionally hold in mind.

Through observing various artists' interactions with paper electronics, I noticed that the artists were not only becoming familiar with the new paper electronics materials. Because it allowed them to use their knowledge of existing materials in new combinations with circuitry, it led them to discover new insights into other mediums that the artists were familiar with. For example, one artist who contributed to Paper Curiosities comes from a background in electrical engineering and also works with stained glass windows in his artwork. However, he discovered new properties of glass as a result of working with it in combination with LEDs for the first time through this artwork. This deepened his understanding of a material that was already very familiar as well as opened up new avenues for future artworks.

In this way, the process of exploration that paper electronics promotes ended up augmenting artists' existing practice not only directly through new techniques, but also in creating an open frame of mind that the materials and tools they have been using all along have new possibilities to be continuously explored, discovered and invented.

## 6. Community

In combining the disparate fields of paper craft and circuit building, I aim to broaden participation in creating technology. I designed the circuit stickers toolkit to be a friendly resource for anyone to enter the world of paper electronics. After releasing the circuit stickers toolkit into the wild through Chibitronics, I wanted to see who actually used the kit and how they did so, using this group as a sample of the larger paper electronics community. My main research questions are:

- What communities are engaging in paper electronics and how are they different from traditional technology-making communities?
- What are the unique needs and values of these communities so that we can design tools and resources specific to them?

I'm especially interested in reaching individuals and communities that are traditionally underrepresented and underserved in technology-focused domains. Ultimately, I hope to gain insights for designing resources that appeal to the specific needs and values of these diverse communities to help close the gaps in gender and diversity participation in technology fields.

Inspired by Buechley and Hill's "LilyPad in the Wild" study (Buechley and Hill, 2010), which looks at engagement in e-textiles through the lens of the LilyPad Arduino toolkit, I first looked at user demographics and backgrounds for Chibitronics. By analyzing sales data, I found the gender ratios and locations of people who are using these tools. I then looked at websites that link to the Chibitronics website to see web documentation of what paper electronics creators are making. Through analyzing and categorizing these webpages based on what was produced, how the creators approached the tools, and the creators' backgrounds, I noticed three main sub-communities emerge within paper electronics: educators, Makers and crafters. This chapter shares my findings.

I start with an analysis of Chibitronics user community demographics, focusing on gender participation. Then I provide an overview of artifacts and approaches unique to the educator, Maker and crafter sub-communities. I conclude with reflections on how these results from paper electronics may change the narrative around who creates technology and how they do so.

## **WHO IS PARTICIPATING?**

Now that paper electronics is out in the world, we are curious to see what types of people and communities are using this medium. In particular we would like to see how these individuals might differ from those that typically engage in electronics and engineering activities. In our investigations we use Chibitronics users as a representative subset of the paper electronics community since it is one of the earliest paper electronics toolkits designed for and made commercially accessible to the general public.

The following sections detail how we used sales orders and website analytics data from Chibitronics to determine the demographics and backgrounds of the paper electronics community.

### **User Demographics**

First we looked at who was purchasing Chibitronics products to get a general sense of user demographics, with a particular focus on gender.

For early Chibitronics customers, I obtained the list of our crowdfunding campaign backers and pre-order sales from Crowdsupply.com. This list covers orders from when we first launched our campaign in November 2013 to when we switched to our own online shops in October 2014.

For current customer data I focus my study on individual orders from our online shop at Chibitronics.com and orders made through Amazon.com, which is a general ecommerce website. While these two vendors do not cover all customers, Chibitronics.com and Amazon.com are the top two sales channels for Chibitronics, currently making up approximately 60% of sales by volume. I obtained order data from when we opened our online shops in November 2014 through June 2016 for both Chibitronics.com and Amazon.com.

For each of these sources, I compiled a list of order names and country of origin for the orders. Over 90% of orders on Crowdsupply came from the US, Canada and Europe. For Chibitronics.com and Amazon.com, over 90% of orders came from the US and Canada. To create the gender demographics sample, first I removed orders from institutions and distributors to assess individual users. I then manually hand coded the names by gender. For example *Jane* would be coded as female and *John* would be coded as male. Gender-ambiguous names like *Nat* and non-identifying accounts like *N.* were classified in a separate category labeled unknown.

Table 6.1 and Figure 6.1 show the results of this initial analysis. The number of samples from Crowdsupply.com (N=648), Chibitronics.com (N=1732) and Amazon.com (N=2872) are shown classified by gender with the ratios of the total samples from that website shown in parentheses. I was able to classify 98% of customers from Crowdsupply.com, 96% of customers from Chibitronics.com and 94% of customers from Amazon.com

**Table 6.1. Gender of customers from Crowdsupply.com, Chibitronics.com and Amazon.com**

Source	Female (%)	Male (%)	Unknown (%)	Total Sample
Crowdsupply.com	119 (31%)	436 (67%)	13 (2%)	648
Chibitronics.com	1287 (74%)	392 (23%)	53 (3%)	1732
Amazon.com	1956 (68%)	752 (26%)	164 (6%)	2872

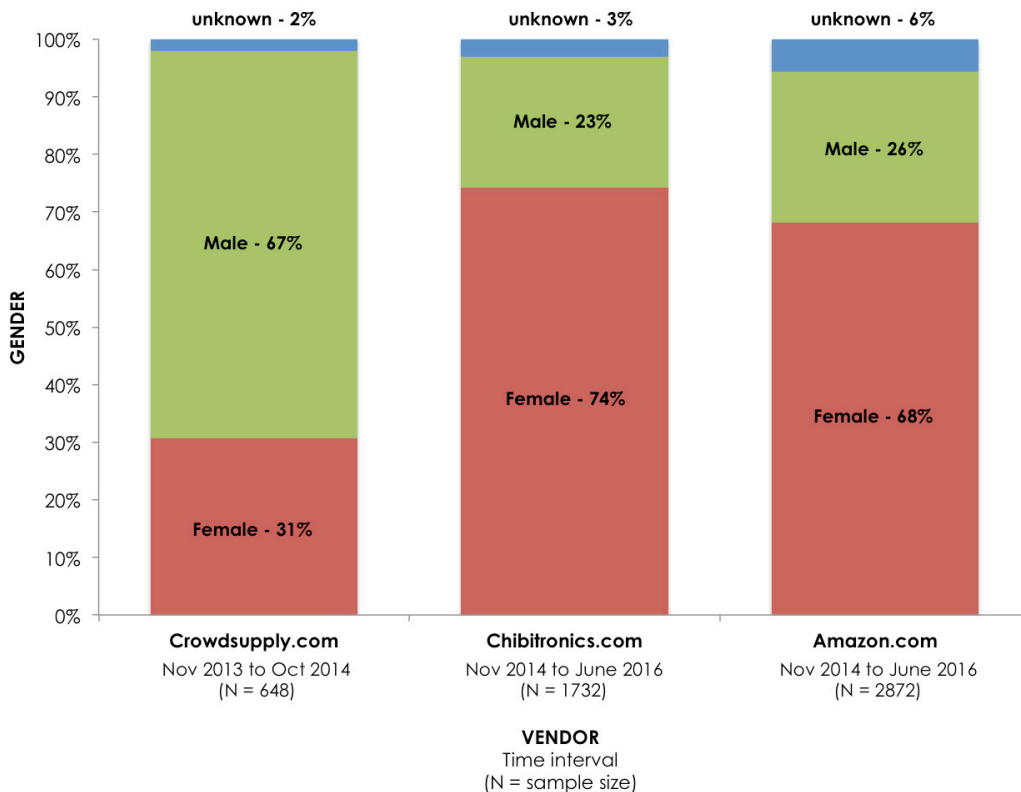

**Figure 6.1. Gender of customers from Crowdsupply.com, Chibitronics.com and Amazon.com**

On Crowdsupply.com, 31% of the order sample were from females and 67% were from males. However, on Chibitronics.com and Amazon.com this ratio is reversed. 77% of the sample for Chibitronics.com and 68% of the sample for Amazon.com came from female customers while male customers made up 19% and 26% of the samples, respectively.

From this initial analysis I noticed the large reversal from majority male customers to majority female customers when we transferred from Crowdsupply.com to Chibitronics.com and Amazon.com. An explanation for this reversal may be in the difference in audience of each vendor as well as the different timing of the samples.

Crowdsupply.com typically focuses on emerging electronics products, which have largely male audiences, while Chibitronics.com was designed to engage more female audiences and Amazon.com is a gender-neutral online retailer for general products.

Since the Crowdsupply.com data covers the period when Chibitronics first launched as a toolkit, orders may have come from typical audiences that are interested in emerging technologies. For example, press for the crowdfunding campaign mostly came from technology-related publications like *WIRED*<sup>41</sup>, which has a 66% male audience on the web<sup>42</sup>. Chibitronics.com and Amazon.com data cover orders from later periods. By this time the toolkit had become better known beyond the emerging technologies community, perhaps leading to more diverse audiences and thus more orders from female customers.

To learn about change in customer gender ratios over time, I combined the Chibitronics.com and Amazon.com samples, then split them into 6-month intervals and recalculated the gender ratios across these intervals. I used the following four intervals: November 2014 to April 2015, May 2015 to October 2015, November 2015 to April 2016 and May 2016 to June 2016. The last interval is shorter since the remainder of the data for 2016 is not yet available. Table 6.2 and Figure 6.2 show the results of this second analysis.

We observe that from the time we launched our shops through June 2016, on Chibitronics.com and Amazon.com the majority of people who purchased Chibitronics products have been female. Furthermore, there has even been a steady increase in the ratio of orders from female customers over this period. The percentage of orders from female customers rose from 66% to 78% and for male customers the percentage declined from 30% to 18% while orders from customers of unknown gender stayed steady between 4% and 5%.

Following these initial results we wanted to further investigate the backgrounds of our users, to see what communities they came from.

---

<sup>41</sup> Clark, Liat. (2013). "Circuit Stickers' creators want us to build stories using electronics"  
<http://www.wired.co.uk/article/circuit-stickers>

<sup>42</sup> Wired Circulation Demographics (2016). <http://www.condenast.com/brands/wired/media-kit/web>

Table 6.2. Gender ratios over time of combined order samples from Chibitronics.com and Amazon.com. Percentages of total sample are shown in parentheses.

Interval	11/2014 - 4/2015	5/2015 - 10/2015	11/2015 - 4/2016	5/2016 - 6/2016
Female	488 (66%)	548 (68%)	1586 (70%)	631 (78%)
Male	223 (30%)	209 (27%)	568 (25%)	114 (18%)
Unknown	29 (4%)	39 (5%)	117 (5%)	32 (4%)
Total N	740	786	2271	807

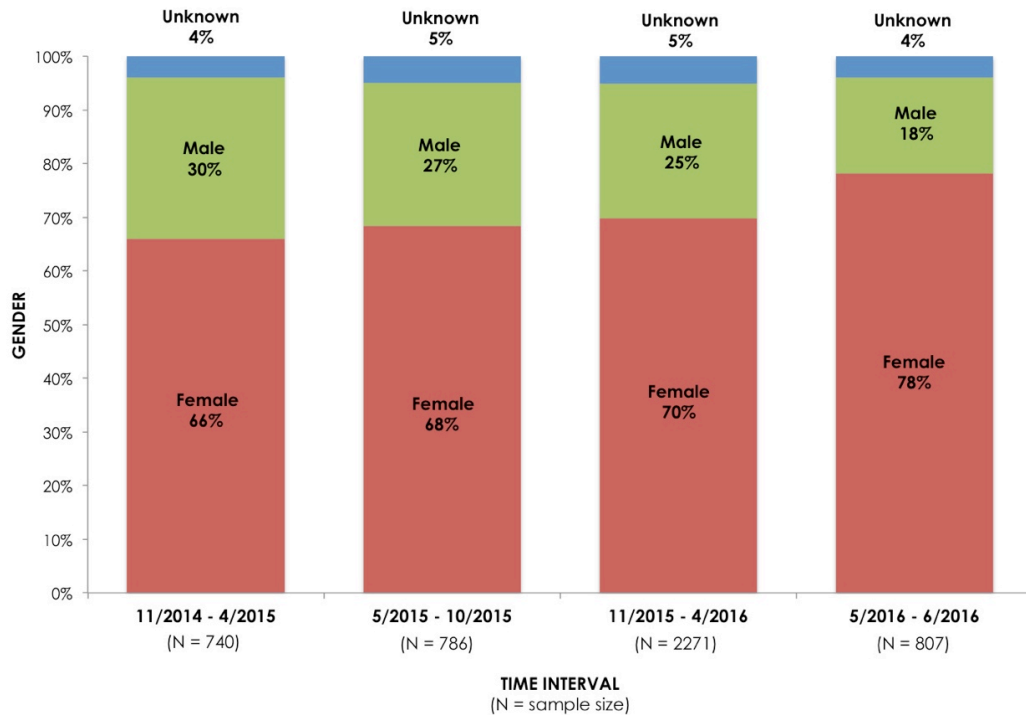

Figure 6.2. Gender ratios over time of combined order samples from Chibitronics.com and Amazon.com.

## User Communities

We used public online project documentation to learn more about the backgrounds of paper electronics users. To create our documentation sample, I used Google analytics to collect a list of all unique websites linking to the Chibitronics.com homepage and our *learn* and *education* subpages as of June 7, 2016. These webpages hold the majority of our online resources and thus are most often linked to.

With the help of an undergraduate research assistant, we cleaned the data set by removing expired and unresolvable website links and kept only websites that have original content, those that did not simply repost from another website. Multiple webpages by the same author on the same website, for example from a personal blog, are categorized as a single sample. Pages written by different authors on the same website,

such as tutorials by submitted different users on Instructables.com, are categorized as separate samples. We came up with a total of 268 unique samples in our set.

We analyzed the sample by looking at what the webpage author created and how they created, what they used their creations for and how they documented their process (these are described in more detail in the next section). We also looked at how contributors self identify on website profiles. Based on these factors, we created categories for the largest sub-communities that emerged from this analysis and used them to classify the sample. We used the following sub-community categories: educator, Maker, crafter, artist, designer and other.

Those who used paper electronics primarily to teach others, such as teachers or librarians, were categorized as educators. Example posts include classroom activity reports and lessons plan resources for others to facilitate teaching with paper electronics.

Makers denote people who are part of a growing movement promoting hands-on creation rather than consumption of technology and a do-it-yourself approach to making and inventing these technologies (Anderson, 2012). These individuals mainly create paper electronics for themselves and focus on exploring the technical construction and functionality of their projects. They also typically use digital fabrication technologies like 3D printing or laser cutting during the process of building their creations. For more on the Maker Movement, see *Chapter 2: Background, Do-It-Yourself Electronics*.

We define crafters as those who created paper electronics projects for themselves as personalized home decorations and memorabilia or as personalized gifts for others. Crafters tend to value outward aesthetics of their creations most and spend the majority of their creative process on personalizing and decorating their projects. Many crafters incorporated pre-defined visual styles through tools like stamps and patterned paper.

Artists and designers refer to individuals who identified as such in their profile pages and typically used paper electronics for personal research purposes. We used “other” as a category for individuals who self-identify under other professions such as mechanical engineer or baker.

However, these categories are not mutually exclusive. For example someone can be both a Maker of paper electronics in their own work as well as a teacher of others. Or, someone may be a professional artist and also self-identify as a crafter. As a result, these classifications only provide a general approximation of the main sub-communities who are sharing online about their paper electronics experiences. The results of this analysis are shown in Figure 6.3.

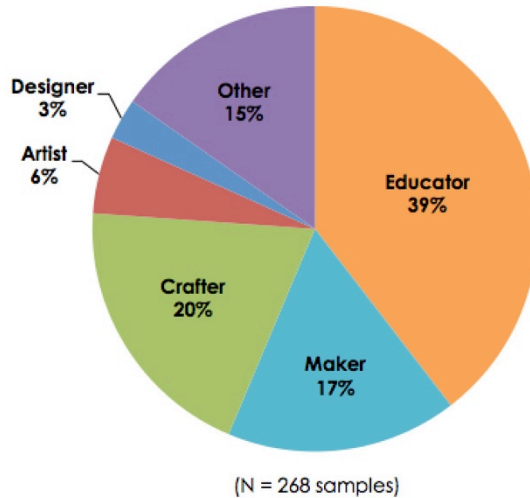

Figure 6.3. Sub-communities of webpage authors linking to chibitronics.com and resource pages.

After categorizing the webpages by sub-community, we then subdivided the authors for each sub-community by gender to investigate whether different communities resulted in varying gender participation ratios. We also wanted to see how the demographic data from online documentation compared to our sales order analysis. For this investigation we hand-coded the author gender based on author information provided on the webpage. We classified webpages whose author names are ambiguous, pages without specified authors and pages representing organizations as “unknown.” The results of this analysis are shown in Figure 6.4.

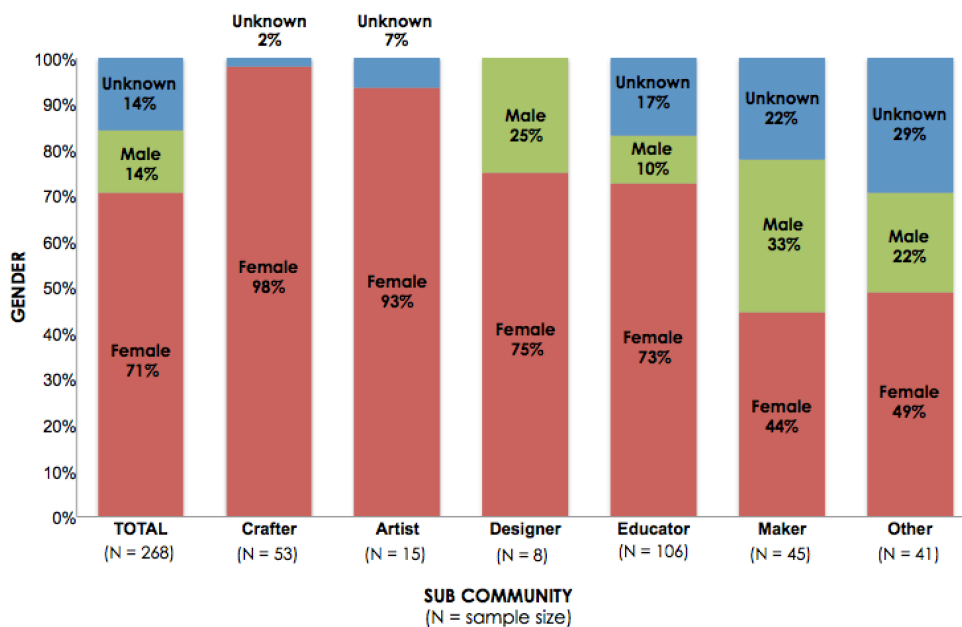

Figure 6.4. Gender of webpage authors linking to chibitronics.com resources by sub-community



Our results show that educators, crafters and Makers are the largest sub-communities sharing online documentation about their paper electronics experiences, making up 39%, 20% and 17% of the total sample, respectively. Gender ratios also varied for each sub-community. 73% of posts from educators and 98% of posts from crafters were from female authors. However, in the Maker community, only 44% of posts were from females.

Overall ratios found from the webpage contribution data approximately follows ratios found from sales data: 71% of overall posts were from female contributors, 14% were from male contributors and 14% of contributions were unknown while overall 70% sales orders for Chibitronics.com and Amazon.com came from female customers, 25% came from male customers and 5% were unknown. Worth noting is that a higher ratio of website contributions came from authors of unknown gender. This may skew our findings in that, for example, more female authors than male authors or vice versa may decide not to include identifying information on their webpages.

## **Analysis**

Our initial study shows that a large majority of paper electronics creators and documentation contributors are female. This contrasts significantly from the demographics of typical electronics and engineering communities, which are mostly male-dominated fields. According to a Computing Research Association study in the United States and Canada for 2013-2014, 85.3% of bachelor's degrees, 71.3% of master's degrees and 81.1% of doctorates in the fields of computer science, computer engineering and information sciences were awarded to male students (Computing Research Association, 2015). Another study from the National Science Foundation found that in the United States in 2010, 75.3 % of managers in science and engineering occupations are male (National Science Foundation, 2010). Even within the emerging Maker community, which is also male-dominated—89% of authors or featured makers in sampled articles of Make Magazine were male (Brahms and Crowley, 2016)—we found more paper electronics contributions from female authors (44% of the sample) than male authors (33% of the sample).

We are especially excited to find adoption of paper electronics by individuals from outside engineering focused communities like educators and crafters, which are also both primarily female communities.

In the US, 87% of primary school educators and 67% of secondary school educators are female according to the most recent report from the World Bank (World Bank Group, 2016), which reflects in the gender ratios of paper electronics educator contributors. Furthermore, despite being a medium based on building circuitry and engineering

practices, not only STEM (science, technology, engineering and mathematics) educators, but also those teaching humanities and arts are using paper electronics in their classrooms. This widens perspectives within the education community of both who can teach engineering practices and how to do so.

Meanwhile 72% of crafters in the US are female with median age between 35 and 44 according a recent report from the Craft and Hobby Association (Craft and Hobby Association, 2012). The overwhelming majority of female crafters building paper electronics, 98% according to our data, confound typical gender patterns of those who build electronics, which is typically considered a masculine activity. Worth noting is that we see engagement in paper electronics at all from mainstream crafters – a community made up of adults who sometimes use electronic technologies in their creative practice but are rarely thought of as its creators. Their participation challenges both gender and age stereotypes, showing that we can design tools that successfully inspire women of all ages to learn new circuit concepts and create electronics who may not have otherwise.

By engaging new communities in creating technology with paper electronics, we also observe new varieties of technologies and resources being made as a result. Now we shift the emphasis from who is creating to what and how they are creating.

### **WHAT ARE THEY CREATING?**

Our online documentation analysis shows that the paper electronics community is made up of multiple sub-communities. The biggest are educators, crafters and Makers. Each has their own unique values and approaches, which reflects in what they create.

In this section we examine artifacts and documentation from websites that link to Chibitronics to learn more about how these three sub-communities differ from each other, as well as how outputs from the paper electronics community differ from those created by typical electronics and engineering communities. We then look specifically at crafters, a new subset of the paper electronics community that is particularly unique in terms of demographics and values. I conclude with a reflection on how such engagement may change the narrative around technology to be more diverse and inclusive.

### **Example projects from educators, Makers & crafters**

For this study we looked at webpage content from the online documentation study and examined the types of projects and resources, format of documentation and platform for publication. We chose a few examples of commonly observed types of artifacts for each sub-community, which are shown in Figure 6.5. While these selected samples may not necessarily be representative of the entire sub-community, we can still use them as a

starting point for discussion. These and other paper electronics projects show how, in addition to electronic functionality, there is often a clear form and aesthetic that is unique to its creator. In fact in many projects, the circuit functionality is secondary to the function of the artifact, for example it may be used as decoration or to highlight part of an image. This is very different from traditional electronics projects, which focus on technical functionality.

Many creators personalize their projects by adding text and images or incorporating their own tools and materials. Such practices make the artifacts further specific to the sub-community as well as the individual creator. These customization practices are less common and often more difficult to do with traditional circuit building mediums, where customization often requires creating an enclosure around the electronics. Instead with paper electronics, creators can create on or around the circuit or even use circuits to decorate an enclosure. However, by looking at the example images below from students and educators, Makers and crafters, we also see some clear differences between what different sub-communities within the paper electronics community create.

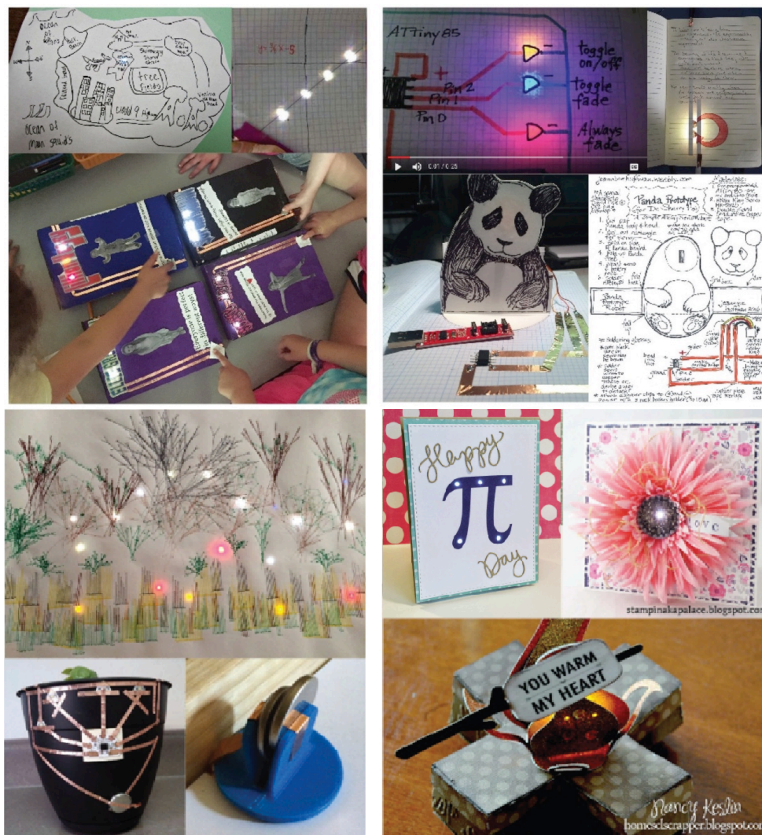

Figure 6.5. Paper electronics projects by students of Susan Watson, Lee MacArthur and Colleen Graves (upper left); educators Jeannine Huffman and Julie Willcott (upper right); Makers Josh Burkner and Coercionette (lower left) and crafters Christina Hsu, Karen Jiles and Nancy Keslin (lower right).

Example projects created by students (Figure 6.5, top left) exhibit a wide variety of classroom applications, from an illuminated treasure map in geography class taught by Susan Watson<sup>43</sup>, to highlighting points on the graph of a math equation taught by Lee MacArthur, to personalized journal covers created by middle school girls as part of the Circuit Girls group organized by Colleen Graves<sup>44</sup>. Examples created by educators (Figure 5, top right) show educator Julie Willcott's notes while learning to program a microcontroller, prototypes for classroom activities and a hand-illustrated printable handout for a paper panda robot programming activity by Jeannine Huffman<sup>45</sup>. It is worth noting that the educators' approach is often to simultaneously teach circuitry while also using it to engage students in entirely different subjects like environmental studies or creative writing. For more examples and deeper discussion on how educators have used paper electronics, see *Chapter 4: Education*.

The images on the lower left of Figure 6.5 show examples of projects shared by Makers. One project is from a tutorial for an electronic plant monitor that tells the owner when to water the plant, by Instructables user Coercionette<sup>46</sup>. The other project is an illuminated computational illustration drawn by a robot, designed by Josh Burkner<sup>47</sup>. This piece also features a 3D-printed battery holder designed by the creator of the piece. These projects are examples of how Makers often create artifacts where electronic functionality is at the core of the project.

It is also common to see Maker projects integrate many technologies and processes, especially ones involving computation and digital fabrication, as it is often the technical functionality and inventiveness of a project that is most valued. Interestingly, we have observed that though Makers may begin learning electronics with paper circuits and the Chibitronics toolkit, many move on to more traditional electronic components and toolkits as they become proficient. One reason may be that paper circuits have been designed primarily to introduce beginners and thus, despite having more complex modules like sensors and programmable microcontrollers in the Chibitronics toolkit, they may be perceived as technologically too simple to support the needs of advanced creators.

---

<sup>43</sup> Watson, S. (2014). "Throwing light on circuits." <http://teachingbeyondtropes.blogspot.com/2016/07/throwing-light-on-circuits.html>

<sup>44</sup> Graves, C. (2015). "Circuit Girls and Donors Choose." <https://colleengraves.org/2015/05/10/circuit-girls-and-donors-choose/>

<sup>45</sup> Huffman, J. (2015). "Paper Circuit Resources." <http://jeanninehuffman.weebly.com/paper-circuit-resources.html>

<sup>46</sup>Coercionette. (2014). "Chibitronics Plant Monitor." <http://www.instructables.com/id/Chibitronics-Plant-Monitor/>

<sup>47</sup> Burkner, J. (2016). "Cybernetic Forest." <http://joshburkner.blogspot.com/2016/06/cybernetic-forest.html>

Finally, the images on the lower right of Figure 6.5 are example projects from crafters, which include illuminated greeting cards by Christina Hsu<sup>48</sup> and Karen Jiles<sup>49</sup> and a glowing gift box by Nancy Keslin<sup>50</sup>. These projects tended to be artifacts where function of the object is embellished by paper circuitry, rather than defined by it. That is, in the examples above, the greeting cards and gift box would still function as elaborately decorated and personalized gifts even if the circuitry were not working or not present at all. Projects made by crafters also tended to be very personal, for example as handmade gifts for others, souvenirs to commemorate a particular event or decorative pieces to inhabit the home. They are often made with a wide range of tools to help ensure a visually pleasing outcome, like rulers and grids, stamps and stencils, patterned paper and pre-assembled collage accessories.

Paper electronics projects from crafters show a clear aesthetic that very closely preserves that of typical paper craft artifacts. They tended to show off traditional craft materials like paper and fabrics decorated with illustrations, graphics and text while the physical circuitry is generally hidden away and only the lights shine through. Their projects have technology in them, but do not scream it. Instead light and interactivity take on a more symbolic role in support of the project's expressive theme, such as illuminating the glow of a candle or representing the warmth of a fire.

Now that we have a sense of what educators, Makers and crafters are creating with paper electronics, let's examine how they have documented and published their projects to learn more about the most valuable types of resources for each community.

### **How they shared**

Access to personal publication tools on the Internet has been crucial to the spread of ideas and inspiration among creators and subsequent growth of the paper electronics community. While everyone uses common social media channels like Facebook, Twitter, Pinterest and Instagram to publicize their posts, there is a difference in what educators, Makers and crafters document and publish that reflect the specific needs and values of their community.

Educators often posted about their classroom experiences on personal websites and social media channels like Facebook and Twitter, which celebrated their students' work while also providing inspiration for other educators. With paper electronics being so new to

---

<sup>48</sup> Hsu, C. (2015). "Happy Pi Day!" <http://bubblegumpaper.blogspot.com/2015/03/happy-pi-day.html>

<sup>49</sup> Jiles, K. (2016). "Happy Valentine's Day!! Love Card Tutorial." <http://stampinakapalace.blogspot.com/2016/02/happy-valentines-day.html>

<sup>50</sup> Keslin, N. (2015). "You warm my heart light up box." <http://homesclscrapper.blogspot.com/2015/04/you-warm-my-heart-light-up-box.html>

many, these educators tended to document their own learning process as they went along by sharing works in progress, insights, challenges and questions. In turn they received support from the community as they navigated these explorations. Educators also generated resource materials for themselves and others to use in the classroom, like lesson plans and templates in the form of webpages, printouts and presentation slides. These resources included not only the materials and procedure for the activity, but also questions and rubrics for assessment, learning standards and goals and related activities for further investigation.

There is similarly a culture of open documentation and sharing within the Maker community, especially as creators are often learning by replicating other's projects or once they have mastered the tools, building upon and remixing each other's work. Part of the culture of sharing may come from the computational and digitally fabricated nature of many Maker projects. With computer programs and CAD design files already in a format that is easy to share electronically, it lowers the effort for designers to publish what they create. With the proliferation of standard digital fabrication machines like laser cutters, 3D printers and CNC routers that can translate these files into physical artifacts, Makers can directly replicate and build upon designs by others, as well as enjoy seeing their own ideas help shape what is made by the community. For paper electronics, since the making process is manual, we have seen mostly Makers document finished projects that show a particular electronic technique or invention, or the project involves paper circuitry integrated with other digitally fabricated and computational mediums.

Crafters tend to share their projects on personal blogs with very specific aesthetic and material genres that expressed their unique tastes and craft practice. Crafters are also more likely claim ownership of their creative work by imprinting their logo, names or web addresses onto the images of their creations. A common way of documenting process is through video tutorials showing the sped-up process of exactly how the project was made from beginning to end along with verbal explanations and captions. This makes it extremely clear for other crafters to follow.

Some of the posts featuring Chibitronics were created by professional craft bloggers who designed example projects and shared tutorials for us in exchange for complimentary products, a common practice within the craft community. While these posts are biased toward polished and successful outcomes, the projects were created without guidance and thus show authentic possibilities for paper circuits in the hands of expert paper crafters.

Because the crafters are so different from typical technology creating communities, we decided to look more deeply at how and why they participate in making paper electronics.

## Circuits meets crafters

Crafters may have been excited about adding electronic functionality to their projects all along, but have not had the appropriate tools to do so until now. As blogger Susan Brown writes:

The Chibitronics lights bring a whole new dimension to crafting and it was fun as I learned about electronics too!! I can't wait to use these in my papercrafts and handmade cards... watch out Hallmark... I have special effects too!<sup>51</sup>

Participation in paper electronics from mainstream crafters is especially exciting to see as they have shown a particularly deep engagement with the material possibilities of paper electronics and while still preserving the strong aesthetic styles and themes typical of the mainstream craft community. Such participation has only blossomed in the past year so the following observations are new and likely to continue evolving as the community, hopefully, further integrates paper electronics to be a standard part of the medium.



**Figure 6.6. From left to right: example craft projects that use circuit sticker circuitry to embellish a plastic cast resin charm by Susan Brown, a glass picture frame by Nadine Carlier and a gingerbread house by Ashley's Atelier.**

Though the circuitry is generally the same: either a single LED or several LEDs in parallel powered by a battery, we have seen very diverse project outcomes made by crafters. For example they have taken paper electronics beyond flat illuminated images to create complex three-dimensional forms, such as the gift box on the bottom right of Figure 6.5. Though we introduced the stickers as a paper craft activity, crafters have also begun integrating circuitry into other materials as decoration, shown in shown in Figure 6.6, such as cast plastic charms<sup>52</sup>, decorating picture frames<sup>53</sup> or even a gingerbread house<sup>54</sup>.

<sup>51</sup> Brown, S. (2016). "Add Some Light to your #Cre8time with Chibitronics and Designers Craft Connection." <http://sbartist.blogspot.com/2016/04/add-some-light-to-your-cre8time-with.html>

<sup>52</sup> *ibid.*

<sup>53</sup> Carlier, N. (2016). "How to light up your picture frame with Chibitronics w/ video." <http://deflectotocraftwith.blogspot.com/2016/05/how-to-light-up-your-frames-with.html>

<sup>54</sup> Ashley's Atelier. (2014). "Gingerbread house: art meets geek." <http://ashleysatelier.com/?p=670>





**Figure 6.7. Example cards showing slide switch (left) and integration sound (right) by Eikohara<sup>55</sup>**

Within the paper medium, crafters have integrated mechanical and paper-engineering techniques to add interactivity and enhance the narrative in their creations. For example the left of Figure 6.7 shows a card where the bears’ hearts glow when one bear slides close to another. The creator has designed a custom slide switch that uses foam to press a paper switch underneath the bears. The card is otherwise composed of decorative papers and stamp illustrations from standard paper craft kits.

By comparison, even though educators have been using paper electronics in the classroom for much longer, we have seen much slower growth in the depth of educators’ and students’ paper engineering explorations. This may be because there is so little time to work with students on more labor-intensive projects and the focus is often on developing complexity through new types of circuitry. Similarly, Makers have also been using circuit stickers and paper electronics for much longer than crafters but tend to push complexity within the electronic and computational domains, for example trying out more advanced circuitry by integrating paper electronics with other types of circuit boards or programming their projects.

That said we are beginning to see crafters incorporate new electronic technologies as well. For example the card on the right of Figure 6.7 uses a pre-made sound module that plays “Happy Birthday” when the bird slides close to the cat. This may be evidence that the simple LED circuit cards may be acting as an on-ramp for crafters to advance on to more technically complex creations. Perhaps the creator would not have thought to try out the sound module had she not used simple lights and then switches in her cards first.

Further evidence that crafters are expanding their paper electronics toolset is shown in Figure 6.8, which shows a video tutorial by a crafter explicitly titled, “LED Cards –

<sup>55</sup> Eikohara. (2016). <https://www.instagram.com/eikohara/>

without Chibitronics – cardmaking tutorial.”<sup>56</sup> In this video the creator shows how to make paper circuitry using surface mount LEDs, copper tape, aluminum foil and conductive silver paint. The title suggests that while crafters may be discovering paper electronics through the circuit stickers toolkit, deemed the default in the title, it is acting as a gateway for them to begin exploring other methods of creating circuitry.

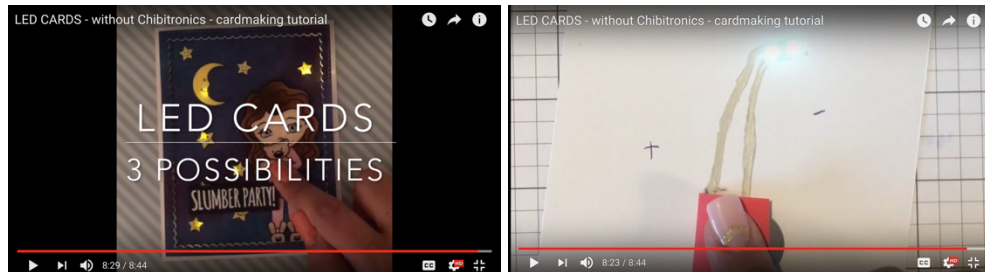

**Figure 6.8. Video tutorial by titled “LED Cards – without Chibitronics – cardmaking tutorial” by Vanilljas**

While these are early observations of crafter engagement with paper electronics, their depth and diversity is promising. It is especially exciting for me to see since these are the exact same types of experiments that I had done when I first began exploring paper electronics while building *Electronic Popables* (Qi and Buechley, 2012). I hope that with time and more specialized resources, crafters might also be inspired to explore the electronic and computational possibilities of paper electronics even further. It was in fact working with paper circuitry that made me fall in love with electronics and programming, perhaps the same will happen for other crafters as well.

### **CHANGING THE TECHNOLOGY NARRATIVE**

Our investigations into the paper electronics community reveal a very different demographic of people producing very different artifacts from traditional technology-making communities – from math educators teaching equations with illuminated circuits to crafters creating glowing gift boxes. Just as the electronic textiles community has organically grown into one dominated by women without specific pressure to do so (Buechley and Hill, 2010), we naturally see female individuals become the majority creators and contributors to the paper electronics community.

With the goal of broadening participation in who is creating technologies by changing the process and types of technological artifacts produced, paper electronics takes what Buechley and Hill call the *Build New Clubhouses* approach, that is, inspiring new communities with different cultures and values around technology than typical

---

<sup>56</sup> Vanilljas. (2016). “LED Cards – without Chibitronics – cardmaking tutorial.” <http://vanilljas.blogspot.com/2016/05/video-sonntag-led-karten-3-moglichkeiten.html>

engineering communities. We see this beginning to happen for example in the humanities teachers using circuit building to teach literature and crafters using LED stickers to illuminate their scrapbook pages – our hope is to provide ways for circuit making and engineering activities to be relevant and exciting to diverse communities.

However, if we are to change the masculine narrative around who produces technology and what types of artifacts they produce, we need to do more than show that women are capable and actively engaging. Instead, the dominant culture must also agree that there is “importance and relevance” for the culture itself (Bers, 1995, p. 25).

For example, traditional makers of electronics may dismiss the glowing notebooks and illuminated paper crafts as too simple and not legitimate engineering. Yet, I would argue that without authentically engaging through these electronically simpler projects, would these same creators be interested in engineering and feel confident in themselves enough to want to create more complex projects?

Another way to look at it, literacy means being able to read—whether it’s reading a novel, a newspaper, a text message or a shopping list, as long as one can decipher the characters, one can think and communicate through written language. Similarly, building circuitry is still building circuitry regardless of whether it uses wires and breadboards to build a robot or tapes and stickers to create an interactive poster. Both require an understanding of electronic principles and enable creators to express themselves through controlling the flow of electricity.

While the projects created with paper electronics may look simple, their complexity is often hidden or simply different from that of traditional electronics projects. For example, crafters need design for the final visual presentation while also ensuring that the circuitry will work. So, in the same way that crafters use tools with pre-designed aesthetics like stamps to help ensure certain visual outcomes, Makers often rely on shields, which are pre-assembled and ready-to-use circuit boards, to simplify much of the circuit design process. For both, the focus is on having a working final project rather than creating the project entirely from raw materials or components. Yet, an electronic project created by plugging together many shields may look more technically complex to build than a craft project made by integrating stamped shapes with circuitry.

Finally, the types of artifacts created using paper circuitry are extremely different and often not possible to create with traditional tools for electronics making. The aesthetic flexibility of the medium results in technologies that are more delicate, expressive and texturally diverse. Just as with electronic textiles projects, artifacts made with paper electronics challenge the norms of what technology can look and feel like. Rather than the actual technical rigor of artifacts made using the paper electronics medium, it may be

this shift in the definition of what “high tech” can be that cause some individuals in traditional engineering communities to dismiss paper electronics as not being a t engineering activity.

Bers also stated that, “once installed into a society, a powerful idea naturalizes itself and appears as if it was always there” (1995, p. 25). Just as electronic textiles are attracting more women into electronics and programming, as well as introducing soft circuitry to the public, we hope that paper electronics will help make crafting circuits an everyday activity for everyone.

In some ways, we may already be seeing this. For example, crafters are using circuitry to decorate their projects as if it was just another embellishment rather than celebrating that most—not all crafters are women— of them are women engaging in engineering activities. Furthermore, these women often have families and thus can now serve as mentors and collaborators for when their young ones are curious or want guidance in creating their own electronics projects, a role once and still typically attributed to fathers. Finally, these women are role models for the younger generation around them, showing how it can be both wonderful and totally ordinary for women to engage in creating technology.

# 7. Future: Paper Programming

Computation enables the systems we build to perform complex operations. In the process of teaching systems these operations, that is, in programming them, we also illuminate our own thinking process. With a focus on intuitively learning through manipulating electronically active materials, how can we encourage such computational thinking and creating with paper electronics?

Currently I have observed the majority of paper electronics learners and creators building circuitry without computation. Missing are complex systems with logic structures that abstract away from the physical structure of the circuit. However, now that these creations can be controlled by electricity, a natural next step is to introduce programming—so that the flow of electricity can also be automated and controlled by logic and algorithms rather than purely mechanical constructions that connect and disconnect power. My current explorations focus on expanding *paper computing* (Buechley et al., 2009) by developing new tools to incorporate programming into paper.

My design inquiries follow two approaches. The first investigation brings code into the material domain with a new set of circuit stickers designed for tangible programming. The second approach integrates standard programmable circuit boards with paper in the form of a programmable clip. The rest of this chapter details the design and functionality of these two programming platforms.

## **CODE COLLAGE: PROGRAMMING WITH CIRCUIT STICKERS**

*Tangible programming* languages use physical modules for constructing programs, providing a hands-on alternative to traditional text-based code for introducing novice programmers to computation.

Many early tangible programming toolkits use physical blocks to program a computer with behaviors shown on a screen such as AlgoBlocks (Suzuki & Kato, 1993) and Tern (Horn & Jacob, 2007). As electronics became affordable enough to build into the blocks themselves, toolkits used visual block-based programming interfaces on the computer screen to program the physical blocks like Lego Mindstorms and PicoCricket (Resnick et al., 1998).

While these approaches separate physical artifacts from digital graphics behind a screen, other kits use only physical electronic modules. Early examples include Electronic Blocks (Wyeth & Purchase, 2000) and Tangible Programming Blocks (Mcnerney, 2004), which are up made of sensing, logic, and output blocks snap together to make functioning programs. Current tangible programming platforms include Block Jam, which uses blocks with screen-based display and input interfaces to creating interactive music (Newton-Dunn et al., 2003); littleBits, which are electronic modules that snap together with magnets (Bdeir & Ullrich, 2009); LightUp, which enables learners to view the inner workings of their program through augmented reality (Chan et al., 2013) and Project Bloks, which is an open hardware toolkit designed for users to create their own tangible programming modules (Blikstein et al., 2016).

My personal focus is to blend the physical programming functionality of tangible programming languages with the material flexibility of paper electronics. With help from Owen Trueblood and Asli Demir, I prototyped a set of new circuit sticker modules called *code stickers*. Individual code stickers are electrically connected using conductive tape lines to construct functioning programs, which I call *code collage*. I was inspired by the wire patch construction style of modular synthesizers<sup>57</sup>, which date back to the 1960's and are in turn inspired by the analog computers from the 1940's<sup>58</sup>. Just as these devices use physical patch programs to create expressive sound, my kit aims to support physical tinkerability so that creators not only make functioning programs but also expressive physical artworks. The visual programming style of the stickers follows the graphical dataflow systems of programming languages like Puredata<sup>59</sup> and Max/MSP<sup>60</sup>, which are used for programming audio and visual effects, and Grasshopper<sup>61</sup>, which is used for algorithmic CAD modeling.

Unlike typical block-based construction kits, which rely on custom rigid mechanical connectors between modules, code stickers connect with flexible tapes on exposed metal pads which both free the physical arrangement of the modules from geometric constraints and make them compatible with standard electronic components.

Writing programs through sticking together tangible modules in different ways keeps programming in the materials domain, where learners can physically tinker with

---

<sup>57</sup> See <http://synth.media.mit.edu/> for an inspirational example of the music and patch programming style of a modular synthesizer. This modular synthesizer, created by Joseph A. Paradiso, currently resides in the Responsive Environments Group space.

<sup>58</sup> 120 years of electronic music (2016). <http://120years.net/>

<sup>59</sup> Puredata. (2016). <https://puredata.info/>

<sup>60</sup> Max. (2016). <https://cycling74.com/products/max/>.

<sup>61</sup> Davidson, S. (2016). Grasshopper. <http://www.grasshopper3d.com/>

computational concepts. Both the program and its implementation are embedded directly into the circuit-building activity so that learners no longer need to mentally and physically switch between hands-on crafting with materials and instruction-based code on a screen. Learners can use their existing expertise with paper electronics to explore the computational capabilities offered by the new code stickers. Keeping the modules in circuit sticker form also maintains all the material and expressive affordances of paper. Rather than programs that abstract into pure functions, the ultimate products of code collages are personalized paper electronics artifacts.

## Code Sticker Construction Kit

Our preliminary implementation of code stickers is based on the concept kit described in *Appendix B: Modular Programming*. Figure 8.1 shows the current set of code sticker modules: record/playback module, light sensor, voltage divider (called a *tuner*) and *compare* logic module. These serve as a basic demonstration of signal generation and introducing computational complexity through logic and record/playback functions.

Each code sticker is a circuit made with copper tape circuitry on paper. The modules are shaped like arrows that point in the direction of signal flow with input at the back of the arrow and output at the point of the arrow. Each sticker has individual power tabs at the bottom edge and an LED displaying the output signal at the top edge. Creators can add more LEDs in parallel to the display LED and use the signal for their scene, in addition to using the signal for coding functionality.

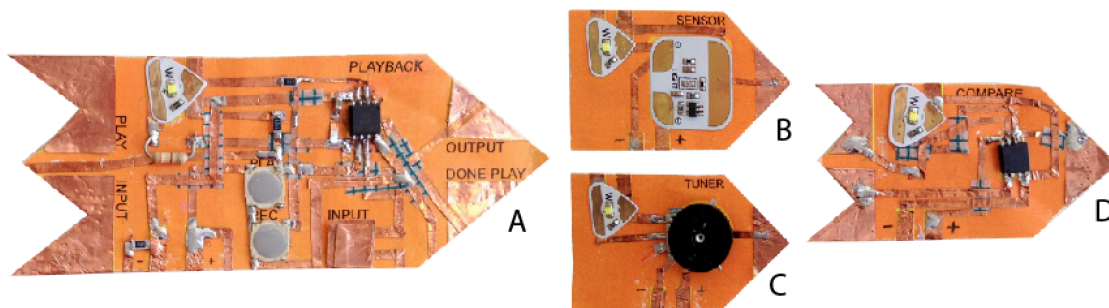

**Figure 8.1:** Code sticker modules: record/playback (A), light sensor (B), voltage divider/tuner (C), compare logic module (D).

Code stickers have on-sticker interfaces for adjusting behavior (Figure 8.2). For example the tuner has a rotary wheel to control the output signal voltage. Some stickers can be controlled by manual controls as well as input pads that respond to electrical signals from other stickers, enabling more complex code collage systems. For instance, to make the record/playback module play, one can press the on-sticker button or trigger the play



input pad with a signal. This module also has a “done playing” output pad which sends a pulse when the sequence finishes. One can connect this output to the play pad to self-trigger repeating looped playback. Interestingly, making this connection with copper tape draws a line from the point of the arrow to the base, creating a graphical loop that mirrors the playback loop behavior.

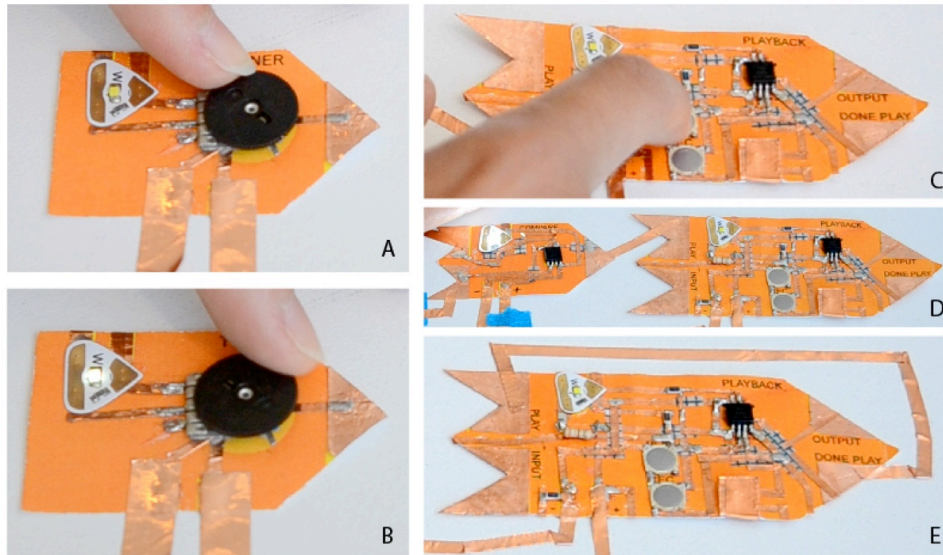

Figure 8.2: Adjusting tuner sticker with knob (A and B). Triggering playback with onboard button (C), external code sticker (D) and self-triggering for repeating looped playback (E).

## Physicality of Code Collages

Figure 8.3 shows an example code collage composed of a light sensor, tuner, compare sticker and record/playback sticker. The playback sticker triggers when the light sensor detects levels below the set threshold. In the scene, when the sun is blocked, the city skyline twinkles on. Since the code collage is flat, we are able to overlay an image over the scene, creating a secondary narrative where when the moon is covered the stars shine above the mountains.

This example shows how copper tape lines electrically connect signals from one module to the next as well as “draw” a graphical mapping of the signal flow. In the same way that written and block-based code makes programs legible and editable through text and image, respectively, code collage transforms the program into a functioning schematic of the electrical system whose behavior can both be visually interpreted and physically manipulated.

Being able to physical arrange code elements anywhere on the page also enables creators to spatially organize their thoughts and their code. In my example skyline circuit, I

placed the sensor and light outputs on the upper portion of the page while the logical operations are placed at the bottom.



**Figure 8.3:** Example code collage of city skyline that glows when the sun is blocked (left) and overlaid secondary story where the stars shine when the moon is blocked (right).

Since code collages are flat, different subcategories of code can also be split into multiple pages and assembled into code booklets. Circuitry from different pages can connect at the booklet’s spine through matching, overlapping traces. See *Appendix B: Paper Programming* for an example project with three distinctive layers: Programming, Sensing/Output and Graphics. Using multiple pages opens additional dimensions for physical organization and gives a sequential structure to the code, going from one page to the next.

While these initial explorations put code collage on two-dimensional pages, and the use of insulating tapes enables creators to layer their circuitry, it is also possible to build collages on three-dimensional forms like a computational skin, or even make moving mechanisms that double as code elements. One can imagine, for example, a mechatronic assembly where part of the assembly is a switch input in for the code.

### **Translating Instruction-Based Programs into Code Collage**

A core goal of code stickers is to translate the computational functionality of instruction-based programming into physical materials, so that one “programs” the circuit through physical manipulation and the behavior of the program is built into its physical form.

As an example translation, I explore how to code the pattern of a blinking LED light, which is where novices often begin their journeys in learning to program circuits. In instruction-based programming, this requires writing code to specify the sequence of turning on and off the light, and the duration of delays in between. The alternative

through code collage is to use the record/playback module to record a pattern of button presses to produce the desired pattern, inspired by the demonstrate-and-record style of programming in Topobo (Raffle et al., 2004).

Instead of needing to translate their pattern into written programming instruction, the creator simply demonstrates the pattern by hand, which can often be more intuitive. However, by the same token, creators are limited to coding only patterns that they can physically generate. Creators lose the precision and power of behaviors specified by instruction-based code—where if you can describe it, the circuit can do it—creators must instead figure out ways to generate the pattern they want. This motivates exploring different types of materials and sensors to create the proper electrical signal.

In the case of making a hard LED blinking pattern, creators can record using a pushbutton, which will only turn the light fully on or fully off. However if they wanted a softer effect, they could record from a pressure sensor, which allows a light to fade on and off. Programming through this method becomes like playing a musical instrument—the outcome depends on one’s physical dexterity. The resulting effects also preserve the hand of the creator. The interaction is like manipulating a singer’s recorded voice through a looping and effects machine, rather than starting from digitally synthesized tones. That is, it starts with the complexity and texture of manual input, which makes for very different styles of final products than starting from code.

Once creators generate their base signal, they can more complex behaviors with other code stickers. For example, logic modules like the *compare* sticker enable the equivalent of instruction-based *if* and *while* statements. As we develop the code stickers toolkit further, we aim to add enough new stickers like logic gates, counters and timers to be able to easily translate any standard code function into code collage.

## Reflections

In the process of designing and constructing these prototype code stickers and the concept implementation in *Appendix B: Programming Paper*, I came up with several preliminary observations about the benefits, drawbacks and challenges for programming circuitry through code collaging:

- **Space constraints:** since the program is built with physical modules and connections, rather than lines of code which can infinity scroll on the screen, the physical size of the program grows with its complexity. Since the modules are flat, one way to create more space is to add more pages. Nevertheless, the larger and

more complex the physical program, the more mechanical issues will likely arise such as the electrical integrity of connections, storage of physically large programs and change due to physical degradation over time. One way to address this may be to laminate the circuitry to protect against potentially corrosive environmental factors like as humidity.

- **Power:** Currently every module needs to be individually powered. However, the power lines take up space and add visual clutter to the code collage. They also make modules more difficult to move around and tinker with. One idea is to separate power lines by putting them on the back side of the page. Power tabs on each code sticker can puncture the page or fold over an edge to access power.
- **Readability:** While all elements of the program are visually presented, it is not clear to me that this style of visual programming is more readable or more intuitive to use than traditional text-based code representations of programs. For example the many lines between inputs and outputs may end up cluttered, like looking at tangled strings. However, with practice I imagine a “spatial grammar” might also emerge to make programs more legible, such as placing power and ground rails along the border of the page or grouping related modules by location.
- **Note taking:** Having labels helps make the visual program much more readable. Writing notes on the connections themselves also helped clarify the functions of the program. Similarly, connecting lines can be colored or marked to add an additional layer of information. In the prototype circuit in *Appendix B*, I used red and black for power lines, green for logical connections and blue for LED output connections.
- **Tinkerability:** Though the visual connections may be harder to read, their open physical nature makes them easier to connect and disconnect. This tightens the feedback loop by enabling real-time testing and iteration rather than waiting for a compile and upload step. Similarly, since code stickers can be easily tuned while the sticker is running, the behavior of the program can be adjusted in real time with immediate feedback, offering a degree of tinkerability that is not possible in typical text-based “compile-run” workflows for programming circuitry.
- **Transferability:** Though code stickers enable learners to play with computational concepts, the process is very different from standard text-based, on-screen coding platforms that control the majority of technology around us. It’s an open question if and how skills learned through code collage transfer to learning

standard programming languages. However, such tangible-based programming does exercise learners' systems thinking. The ability to think systematically and algorithmically is more important than the ability to write in a particular programming language or syntax. It is possible that as technology and programming languages continue to evolve, these text-based languages may one day disappear altogether.

These initial explorations also bring up the important design question behind choosing the right vocabulary as the code collage programming language develops: at what level should functions be black-boxed into primitives? Because we are working at the level of circuits, modules can be as low level as single transistors and capacitors or as complex as fully pre-programmed functions like the record/playback module.

The more functionality is pre-assembled into condensed units, the more scaffolding the modules offer for creators to make more complex computational behaviors. However if complex behaviors are too pre-packaged, we run into the danger of removing programming from the activity altogether, leaving only simple plug-and-play parts. The more low-level detail revealed to learners, the deeper their understanding of the electronics theory underlying their creations and the more access they have to controlling the materials' behaviors. It is ultimately a balance between easily making complex final artifacts that work and revealing the circuit complexity to truly understand the raw computational material.

As tangible programming continues to evolve, our hope is that a standard framework will emerge so that various independent contributors can add to the growing library of physical tangible modules while maintaining compatibility. We have seen such development organically emerge in the modular synthesizer community through the creation of standard physical and design specifications like the Eurorack racking system, which provided a standard physical setup for synthesizer designs, and the 1 volt per octave design standard. Within the tangible programming community, open source initiatives like Project Bloks aim to create such a framework by making their designs open, sharing resources and encouraging collaboration and contributions.

### **CODE CLIP: REUSABLE PROGRAMMABLE MICROCONTROLLER FOR PAPER**

In the spirit of making a programmable paper electronics kit that is accessible beyond the lab, I wanted to create an option that can be easily manufactured at scale and distributed at affordable costs. The focus of this second exploration is how to transform existing programmable boards into a form factor that integrates well with paper.

The circuitry required for programmability makes such modules more expensive than simple LED and sensor modules, so it was very important to make the module reusable and sharable between projects. In the same way that the LilyPad Arduino SimpleSnap<sup>62</sup> uses metal snap fasteners to make the microcontroller module easily attach and detach from the rest of the electronic textiles circuit, I needed a way for creators to remove their microcontroller from the paper circuit without damaging the microcontroller or the rest of the project.

In the end, I decided to move away from the semi-permanent adhesive connections of circuit stickers and toward modules that connect to the circuit temporarily with pressure-based contacts. Inspired by the Storyclip (Jacoby and Buechley, 2013) and the bulldog clip connector (Shorter et al., 2014), which use conductive clip contacts to connect to paper circuitry on the edge of page, I decided to turn the entire programmable board into a clip. Together with Andrew “bunnie” Huang and Sean Cross, as part of Chibitronics, we created a prototype toolkit made up of an Arduino-based programmable clip called the *code clip* and along with it, a standalone mini screen display called the *circuit viewer*.

## Code Clip

The code clip is a programmable microcontroller board assembled in the form of a wide-mouth clip (Figure 8.4). Conductive pads at the mouth of the clip connect the microcontroller to circuit traces at the edge of a piece of paper. Making the board into a clip allows us to easily connect and disconnect it from paper circuitry by clamping it to the page, an electrically secure and also temporary connection. Once creators are ready to embed the programmable board permanently in their project, they can remove the board from the clip and attach it to paper circuitry by sticking with z-tape or soldering.



Figure 8.4: Code clip front view (left), side view (center) and open clip (right).

---

<sup>62</sup> LilyPad SimpleSnap. <https://www.arduino.cc/en/Main/ArduinoLilyPadSimpleSnap> (2016).



Figure 4 shows our current prototype, which uses copper tape to run traces from the microcontroller pads to the mouth of the clip. Our next version will use a hybrid rigid-flex board so that pads of the microcontroller are flexible and can be easily folded over the mouth of the clip, making the clip assembly much easier to build.

The clip form is particularly versatile for connecting to paper electronics, as shown in Figure 8.5. It can clip to pages of traditional notebooks, turning any notebook into a circuit sketchbook, while also acting as a bookmark for the creator's progress. For working with loose, individual paper circuit sheets, the clip can be attached to a rigid board to create a computational clipboard. Finally, clipping multiple pages together creates a computational circuit book. Even though the clip's conductive pads only touch the top page, creators can connect the clip to later pages in the stack by folding conductive tabs around the edge of the paper to connect between the top and bottom of each page.

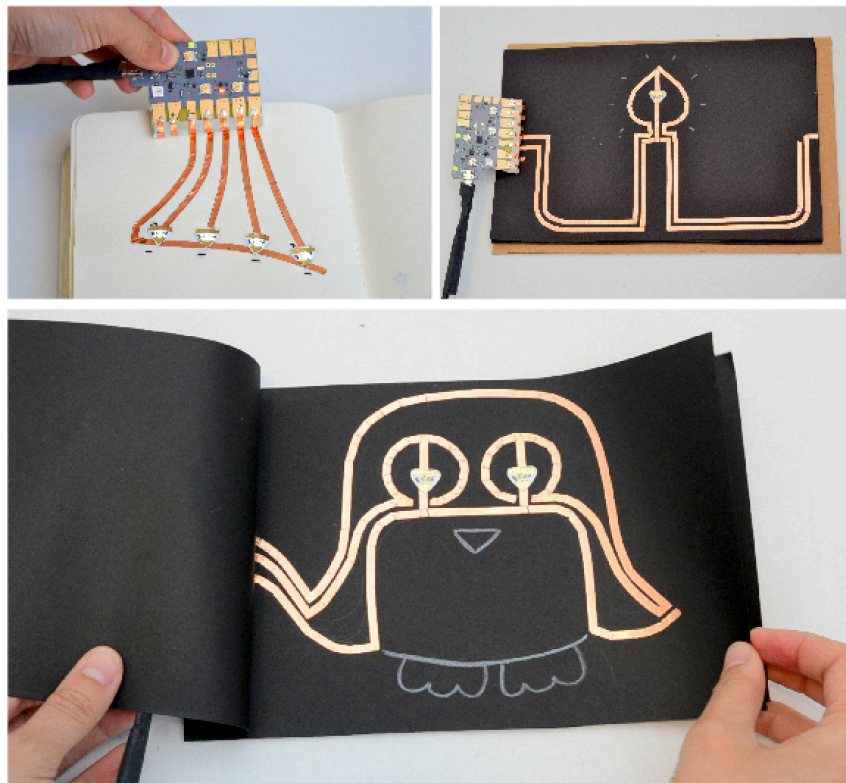

**Figure 8.5: Code clip attached to standard notebook (top left), as computational clipboard (top right) and clipping multiple pages to create circuit book (bottom).**

The programmable board itself uses a Kinetis KL02 microcontroller and has six input/output (I/O) pins, four of which can output PWM signals and read analog input, and transmit/receive (tx/rx) pins for serial communication. The board can be powered



through a mini USB connector or through the power pads, which take any power source between 5V and 6V.

There are also two on-board pushbuttons to, an RGB LED and a single-color LED attached to the I/O pins. The default code on the code clip enables users to record patterns using these onboard components, so that users are introduced to the idea of automation without needing to program. Once they are ready, novices can begin programming circuitry using the on-board components, so they do not to build their own circuit first.

The code clip comes with a custom cable Y-shaped cable. One end connects to the board through micro-USB and the other end splits into an audio cable and standard USB cable. The audio connector takes the ID line of the microUSB and uses it for programming through audio signal (described in further detail in the *Code Clip Programming* section below). The standard USB connector uses the remaining USB data lines for powering the board and communicating with USB devices.

## Circuit Viewer

One of the most useful functions in programming, especially when first learning, is being able to send data from the board to a screen. For example it enables coders to easily put debugging flags in the program to know which part of the code is running or display sensor readings to see if a circuit is connected properly.

While this is typically done through a serial monitor window on a computer screen, we created a miniature viewer that acts as an external and portable serial monitor. We added a simple voltmeter function to the viewer so that it can take both digital readings of data from the tx/rx pins as well as analog voltage readings directly from the circuit. This device, which we call the *circuit viewer*, is shown in Figure 8.6.

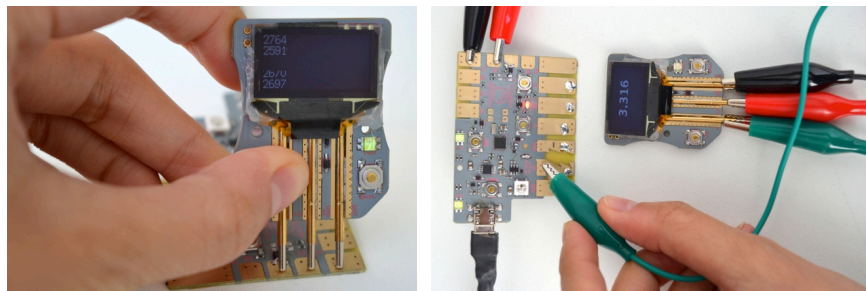

**Figure 8.6:** Circuit viewer connected to circuit with pogo-pins (left) and alligator clips (right).

The circuit viewer has a 1.5 cm by 2.5 cm LCD screen and is powered by connecting to the circuit. There is one button to change between serial monitor and voltmeter modes and another button to pause scrolling on the serial monitor. To make the viewer easy to share, we used pogo-pin connectors, which allow users to push the board down onto matching pads on the code clip for a momentary reading. Alternatively, to make more permanent connections and for hands-free usage, users can clip the pogo pins to their circuit with alligator clips.

## Code Clip Programming

In collaboration with Codebender<sup>63</sup>, we created a browser-based code editor for Arduino programming, so that creators can program the code clip without installing custom software. We also created a custom protocol for uploading code through audio rather than the standard USB.

While audio has been used for data storage since early computers of the 1970's, like the Commodore 1530 Datasette<sup>64</sup> which turns data into analog sound signals for storage on cassette tapes, current data storage and transfer relies on USB as the standard protocol. However, the prevalence of standard audio outputs across more devices than USB—from phones and tablets to earlier cassette tape players and even record players—makes audio-based data transfer compatible across more platforms. As a result, many researchers have investigated ways to use audio for data transfer. One example is the Hijack system which uses phone audio jacks for data transfer and power (Kuo et al., 2010).

Our code editor interface translates binary code into audio sequences, called *code songs*, which plays through the audio jack to the code clip. Custom firmware on the microcontroller then decodes the code song back into binaries for programming. Data transfers at a baud rate of 8kbps. Currently standard hardware programming devices for hobbyists uploads code through USB and requires coders to use a computer. With this protocol, any device that can generate sound can serve as a programmer, such as phones or tablets which are often more accessible and affordable than computers for many learners.

When users click upload on the programming interface, a graphic appears on the screen that displays the audio signal (Figure 8,7). They can hear the code by simply letting the audio play without connecting it to a code clip. We hope that by having text, graphic and

---

<sup>63</sup> Codebender. (2016). <https://codebender.cc/>

<sup>64</sup> Timeline of Computer History. (2016). <http://www.computerhistory.org/timeline/memory-storage/>

audio versions of the same code, novice programmers will gain a deeper intuition for programming as sending a set of instructions uploaded from the programming device to the code clip. In fact, that it is just like uploading a song onto a music player, except instead of playing music, the code song determines behaviors of the circuit.

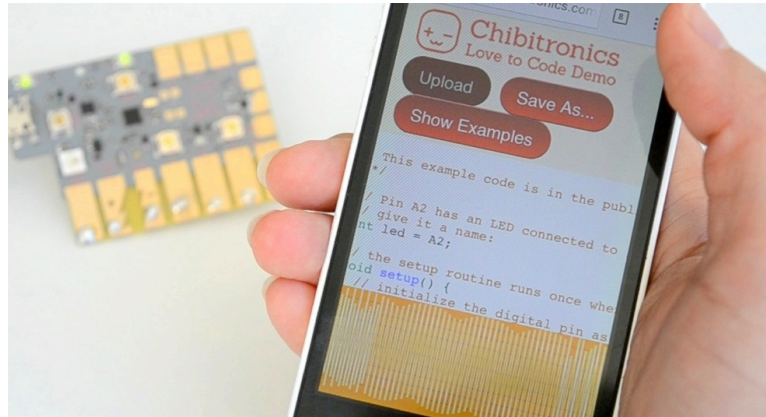

Figure 8.7: Programming code clip through audio with cellphone and browser-based editor.

## Reflections & Further Investigations

The *code clip*, *circuit viewer*, audio-based programming protocol and browser-based interfaces are all early stage prototypes that alternative methods for programming paper electronics as well as for programming in general for current electronics hobbyists. The following are some reflections on interaction possibilities enabled by these tools and directions for further investigation.

- **Code clipping to new materials:** The pressure-based contacts of the code clip can attach to any material thin enough to fit within the mouth of the clip. Beyond paper, it can clip to other materials like wood, glass, ceramic and fabric or even act as the intermediary between multiple materials. For example the clip can connect between circuitry on fabric and circuitry on glass. Designers can begin their project prototypes on paper and move onto another material for the final project, while using the same programmable board. While this can also be done through alligator clips, having all of the mechanical connections on one object and in one clip motion simplifies and condenses the connection process, rather than needing a new alligator clip for every connection.

Connections between rigid electronic boards and soft, flexible and stretchy materials like fabric are especially challenging given their different mechanical

properties, which produce areas of force concentration and are often the source of failure. The clip helps alleviate this issue by providing a constant positive force on the connection so that even though the fabric can bend and stretch, the clip will grip the material.

- **Wireless programming with audio:** By adding a microphone to the microcontroller board, it would be possible to wirelessly program by playing a code song out loud to the microphone, like the Aniomagic toolkit but programming with sound rather than light (Elumeze, 2013). Unlike with standard wireless programming methods, this process is simpler and more direct since there is no need for setting up communications between the board and the programmer.

Wireless coding enables one programmer to send code to many code clips, since there is no longer the need for a programmer to connect to every code clip. For example one can imagine a teacher simultaneously broadcast programming multiple code clips in a classroom. Likewise, wireless programming would enable many creators to program the same board easily, without needing to connect and disconnect from the board for every new programmer. Many creators can share one board and one project, helping make the programming experience more collaborative as well as cost-effective.

Finally, it enables creators to easily reprogram projects even if the board is in a difficult to reach location. For example, the audio could travel through materials to program a board that is permanently embedded in a project. Or, in other cases electrical contact with the board may be difficult to maintain, such as if the microcontroller were underwater or in constant motion. In fact, sound travels more effectively in water than in air, making sound-based program uploading particularly fitting for underwater scenarios.

- **Alternative UI's for programming with small or no screens:** Our audio programming protocol opens standard Arduino programming from devices other than laptop and desktop computers, such as tablets or smartphones. However, such devices both enable new interactions like touch screen capability as well as provide limitations like smaller screens and non-tactile keyboards.

While our current browser-based text editor works across many devices, it is challenging to use from a small screen where, for example, it is more difficult than on a traditional computer to select and edit specific portions of the text. As a

result, it is more error prone and generally less comfortable to code from than with a traditional computer and keyboard. One possibility we imagine is an interface like the Arduino extension for Scratch<sup>65</sup> which would be more visual and block-based, and take advantage of touch-screen interactions while also removing the need for editing text.

Beyond these devices, one can imagine programming with alternative devices with simpler functionality like features phones or even devices without a screen like record players. Beyond simply playing back pre-coded songs, new user interfaces can enable coding with these devices as well. For example one can imagine editing code through slicing, remixing and recording snippets of existing code songs, just like editing a musical score.

In addition to exploring these new directions, we plan to implement code clip programming with learners, educators and creators in classrooms, makerspaces and museums to evaluate its effectiveness for introducing programming with paper electronics in diverse settings. Through advancing the computational accessibility of paper electronics, we are excited to see what new audiences we might be able to engage in coding as well as what sorts of new computational artifacts they produce.

---

<sup>65</sup> Arduino extension for Scratch. <http://playground.arduino.cc/Interfacing/Scratch> (2016).

## 8. Conclusion

When I first began exploring paper electronics over six years ago, I fell in love with it as a medium that blended my own interests in art, craft and engineering and made each one better in combination. The paper craft became more magical as it took on the interactivity of electronics, while the electronics became not only more beautiful, but also more meaningful within the context of a crafted scene. Thus began my exploration of electrified craft and expressive circuitry.

I've been working to develop and share paper electronics ever since. Through launching the Chibitronics circuit stickers toolkit, I am able to do research at scale to not only make paper electronics accessible outside of the lab, but also see what happens when it reaches the hands of the public. The following is a summary of what I have learned so far:

- **Education:** Paper electronics offers a way for learners to build electronics with familiar and accessible materials like paper and tape. The building process is quick, which enables learners to make many versions and learn through iteration. These materials also offer much more physical and aesthetic flexibility than traditional tools for learning and teaching electronics. As a result, learners engage through hands-on making of more personalized artifacts, rather than accessing circuitry only at the level of abstract functionality with typical tools.

The flexibility of paper electronics also offers learners many pathways to enter and participate—such as drawing a picture, creating a circuit based on a template, collaging with found materials or drawing with the circuit. This makes circuit building appealing to more learners, especially those who may otherwise be intimidated or feel that such skills are irrelevant.

Paper electronics is also engaging more diverse educator audiences—from English teachers to math teachers to physics teachers. These educators are using it to teach not only circuitry but also other subjects like poetry, geography and literary analysis. The relative familiarity and simplicity of paper has also led educators to create and contribute many of their own tools and resources for paper electronics.

However, not all educators have the resources to purchase custom tools like circuit stickers or copper tape. Luckily more affordable options exist like standard LEDs and aluminum foil, though these come with limitations. For example, standard bulb-shaped LEDs make circuits too bumpy to place images on top and

aluminum foil cannot be soldered to as easily as copper. Also, the semi-permanence of paper electronics adhesive materials also makes it difficult for learners to reuse the materials for more than a few iterations. These are some main challenges to address as the paper electronics medium continues to evolve.

- **Expression:** The *Paper Curiosities* exhibition demonstrates the wide breadth of aesthetic and artistic possibilities of paper electronics in the hands of expert creators. Through artist interviews, we also see how artists can take diverse approaches that incorporate their existing style to creating with this medium.

However, due to the complexity of choreographing mechanical, electronic, aesthetic, and interactive systems all at once, working with paper electronics often meant artists needed to plan or iterate more often than they typically do in order to make the project work.

By exploring paper electronics, many artists not only learned new interactive techniques specific to this medium, but they also discovered new aspects of mediums they were already working, which further developed their existing creative practices.

- **Community:** Using the Chibitronics community as a sample of the larger paper electronics community, we find that approximately 70% of our users are female, which is a reverse in gender ratios from typical technology-creating communities. The community is largely made up of educators, Makers and crafters who are applying paper electronics in very diverse ways—from teaching robotics, to creating electronic inventions to embellishing home decor.

Crafters are an especially surprising community given that it is a majority adult, female community that is not typically associated with making circuitry as part of their creative practice. We see that paper electronics is indeed organically engaging new audiences in creating their own technologies, ones audiences that may not have engaged otherwise.

From these explorations I have also gained some insights into which properties of paper electronics make it work as a learning tool, expressive medium and method for broadening engagement in creating technology:

- **Familiarity:** By using materials that learners and creators are already familiar with, like paper and tape, we allow them to take advantage of knowledge and skills that they already have and add additional value to what they already know. This



minimizes the amount of new information that learners need to acquire before using the new medium, providing an on-ramp from what they know into the unfamiliar. It also means learners are less likely to be intimidated, since these are materials that they already understand.

At the same time, typically we design new platforms and mediums to be *intuitive*—that is, by following norms of interaction we enable learners and creators to more naturally figure out how to use the new interface. However by recycling known materials into the new medium, we also allow learners and creator to use their actual *intuition*, which is built on prior experience with a material.

Their understanding may be even deeper than that of the original medium designer's, leading to surprising outcomes that the original designer many not have imagined, or would not have been able to do. It also means that users are more likely invent new tools, techniques and approaches that the original designer may not have thought of.

- **Flexibility:** As a material, paper has a broad range of mechanical and aesthetic properties and blending it with electronics enables artists to express themselves with interactivity while also maintaining enough aesthetic flexibility to achieve their creative visions through unique styles.

At the same time, paper electronics is also accessible enough for beginners to grasp and work with. When used as a learning tool, the expressive flexibility gives learners the ability to personalize and give context to what they make during the learning process, making these artifacts more personally meaningful. As a result, the skills learned also become more personally valuable.

Flexibility also means having many alternative materials and tools that work within the medium, which makes the medium more accessible as well as more able to grow. More expensive or complex types of materials have more affordable and easier to use alternatives. Experts can use more advanced and specialized tools like soldering irons or paper sculpting techniques. They can even begin incorporate other mediums, like glass or woodworking. Using Papert and Resnick's room metaphor for toolkits, this both widens the walls for what creators can make and pushes up the ceilings for more complex projects (Resnick and Silverman, 2005). It also opens paper electronics to working with other mediums,

which “adds open doors” to the room of creative possibilities.

- **Shareability:** What sustains paper electronics is how easily the medium can be spread. Using relatively common materials and components with many alternatives as well as having digital ways to share through printed templates are two main factors that make paper electronics easy to share. In fact, paper itself is the medium through which mass communication first took off—in the form of print media. Within non-electronic artifacts, print media is still the most pervasive form of mass communication because it's so inexpensive, accepts marks for printing, is collapsible and is portable. These properties transfer over to paper electronics.

By being able to be shared widely, paper electronics inventors and contributors also have an easier chance of getting their ideas out to other users in a way where ideas actually stick and are used. This helps the community to connect and strengthen while growing the medium.

The paper electronics medium is now constantly evolving in an open ecosystem between researchers, educators, designers, artists and entrepreneurs. I see countless avenues in which this medium can lead to new research questions as well as new forms of impact on society as a whole—from how we create technologies, to what technology can be, to who gets to participate in creating it and defining its role in our lives.

As blended mediums like paper electronics gain popularity with broader audiences, it has great potential to change how society views technology and its creators. My hope is that technology will soon become a medium that anyone can create and express with, not just a privileged few, and that this will lead to new genres of technology and experience.

In my own explorations, I'm particularly excited to continue working with paper programming to see how we can add complexity through code to the electronics that we create and use computation as another physical material to tinker with.

# References

- Ackermann, E. (2015). "Amusement, delight, and whimsy: Humor has its reasons that reason cannot ignore." *Constructivist Foundations*. Vol. 10. 3. 405-421.
- Anderson, C. (2012). *Makers: The new industrial revolution*. New York, NY: Random House.
- Andersson, H., Manuilskiy, A., Unander, T., Lidenmark, C., Forsberg, S. and Nilsson, H. (2012). "Inkjet Printed Silver Nanoparticle Humidity Sensor with Memory Effect on Paper." *IEEE Sensors Journal*. Vol 12 (6): p1901–1905.
- Back, M. and Cohen, J. (2000). Page detection using embedded tags. In *Proceedings of the 13th annual ACM symposium on User interface software and technology (UIST '00)*. ACM, New York, NY, USA, 159-160.
- Back, M., Cohen, J., Gold, R., Harrison, S. and Minneman, S. (2001). "Listen reader: an electronically augmented paper-based book." In *Proceedings of the SIGCHI Conference on Human Factors in Computing Systems (CHI '01)*. ACM, New York, NY, USA, 23-29.
- Bacon, W. "Transistors On Paper". *Popular Science* 1968: 124-125.
- Barr, M., Rowehl, J., Lunt, R., Xu, J., Wang, A., Boyce, C., Im, S., Bulovic, V. and Gleason, K. (2011). "Direct Monolithic Integration of Organic Photovoltaic Circuits on Unmodified Paper." *Advanced Materials*. Vol 23. p 3500–3505.
- Bdeir, A. and Ullrich, T. (2009). "Electronics as material: littleBits." In *Proc of TEI '09*, ACM, New York, NY, USA, 397-400.
- Bender, S. (2016). "Electronics Meets Textiles: Sewing the Way to Powerful New Ideas about Technology." In K. Peppler, E. R. Halverson, & Y. B. Kafai, *Makeology: Makers as Learners Vol 2*. Routledge, New York, NY, USA, 125-144.
- Bennett, J. (2001). *The Enchantment of Modern Life*. Princeton University Press.
- Bers, M. U. (1995). *Blocks to robots: Learning with technology in the early childhood classroom*. New York, NY: Teacher's College Press.
- Blikstein, P., Sipitakiat, A., Goldstein, J., Wilbert, J., Johnson, M., Vranakis, S., Pederson, Z. and Carey, W. (2016.) "Project Bloks: designing a development platform for tangible programming for children."  
[https://projectbloks.withgoogle.com/static/Project\\_Bloks\\_position\\_paper\\_June\\_2016.pdf](https://projectbloks.withgoogle.com/static/Project_Bloks_position_paper_June_2016.pdf).

Blikstein, P. and Worsley, M. (2016). "Children are not hackers: building a culture of powerful ideas, deep learning, and equity in the Maker movement." In K. Peppler, E. R. Halverson, & Y. B. Kafai, *Makeology: Makerspaces as Learning Environments Vol 1*. Routledge, New York, NY, USA, 64-79.

Brahms, L. and Crowley, K. (2016). "Making Sense of Making: Defining Learning Practices in MAKE Magazine." In K. Peppler, E. R. Halverson, & Y. B. Kafai, *Makeology: Makers as Learners. Vol 2*. Routledge, New York, NY, USA, 13-28.

Buechley, L. (2013). "Thinking and making." Closing Keynote Talk presented at *Fablearn 2013*, Stanford, CA.

Buechley, L., Hendrix, S. and Eisenberg, M. (2009). "Paints, paper, and programs: first steps toward the computational sketchbook." *In Proc. TEI '09*. ACM, New York, NY, USA, 9-12.

Buechley, L. and Hill, B.M. (2010). "LilyPad in the wild: how hardware's long tail is supporting new engineering and design communities." *In Proceedings of the 8th ACM Conference on Designing Interactive Systems (DIS '10)*. ACM, New York, NY, USA, 199-207.

Buechley, L. and Perner-Wilson, H. (2012). "Crafting Technology: Reimagining the Processes, Materials, and Cultures of Electronics." *ACM Transactions Computer Human Interaction*. 19, 3, Article 21 (October 2012), 21 pages.

Cantrill, C. and Oh, P. (2016). "The composition of making." In K. Peppler, E. R. Halverson, & Y. B. Kafai, *Makeology: Makerspaces as Learning Environments Vol 1*. Routledge, New York, NY, USA, 107-120.

Carter, D. A. and Diaz, J. (1999). *The Elements of Pop-Up*. Little Simon.

Chan, J., Pondicherry, T. and Blikstein, P. (2013). "LightUp: an augmented, learning platform for electronics." *In Proceedings of the 12th International Conference on Interaction Design and Children (IDC '13)*. ACM, New York, NY, USA, 491-494.

Chitnis, G. and Ziaie, B. (2012). "Waterproof Active Paper via Laser Surface Micropatterning of Magnetic Nanoparticles." *American Chemical Society Applied and Material Interfaces*. Vol 4: p4435-4439.

Cho, S. (2012). *Aesthetic and Value Judgment of Neotenus Objects: Cuteness as a Design Factor and its Effects on Product Evaluation*. Diss. University of Michigan, 2012.

Coelho, M., Hall, L., Berzowska, J. and Maes, P. (2009). "Pulp-based computing: a framework for building computers out of paper." *In Proc CHI EA '09*. ACM, New York, NY, USA, 3527-3528.

Computing Research Association. *2015 Taulbee Survey: Doctoral Degree Production Dips Slightly data*. Retrieved August 11, 2016, from <http://www.cra.org/resources/taulbee>.

Craft and Hobby Association. (2012). 2012 State of the Craft Industry. Retrieved August 11, 2016, from [https://www.craftandhobby.org/eweb/docs/2012.State.of.Craft.Industry\\_Key.Insights.pdf](https://www.craftandhobby.org/eweb/docs/2012.State.of.Craft.Industry_Key.Insights.pdf)

Csikszentmihalyi, C. (1996). *Creativity: Flow and the Psychology of Discovery and Invention* HarperCollins Publishers.

Duckworth, E. (2006). *The Having of Wonderful Ideas: And Other Essays on Teaching and Learning*. Teachers College Press.

Elumeze, N. (2013). "Traveling light: Making textiles programmable "through the air." In L. Buechley, K. A. Peppler, M. Eisenberg, & Y. B. Kafai (Eds.), *Textile messages: Dispatches from the world of e-textiles and education* (p 43-51). New York, NY: Peter Lang.

Fields, D. and Lee, V. (2016). "Crafting Technologies 101: bringing making into higher education." In K. Peppler, E. R. Halverson, & Y. B. Kafai, *Makeology: Makerspaces as Learning Environments Vol 1*. Routledge, New York, NY, USA, 107-120.

Fisher, L. M. (1992). "Plug is Pulled on Heathkits, Ending a Do-It-Yourself Era." *New York Times*, March 30, 1992.

Fisher, P. (1998). *Wonder, the Rainbow and the Aesthetics of Rare Experiences*. Harvard University Press.

Formanek-Brunell, Miriam. (1993). *Made to Play House: Dolls and the Commercialization of American Girlhood, 1830-1930*, Yale University Press, New Haven, Conn.

Freed, N., Qi, J. Setapen. A. (2011). "Sticking together: handcrafting personalized communication interfaces." In *IDC '11*. ACM, New York, NY, USA, 238-241.

Freed, N., Qi, J., Sylla, C. and Branco, P. (2011). "Beyond the binding: exploring the future book." In *Proceedings of the 8th ACM conference on Creativity and cognition (C&C '11)*. ACM, New York, NY, USA, 445-446

Gong, N., Steimle, J., Olberding, S., Hodges, S., Gillian, N., Kawahara, Y. and Paradiso, J. (2014). "PrintSense: a versatile sensing technique to support multimodal flexible surface interaction." In *Proceedings of the SIGCHI Conference on Human Factors in Computing Systems (CHI '14)*.

Grasset, R., Duenser, A., Seichter, H. and Billinghamurst, M. (2007). "The mixed reality book: a new multimedia reading experience." In *CHI '07 Extended Abstracts on Human Factors in Computing Systems (CHI EA '07)*. ACM, New York, NY, USA, 1953-1958.

Haring, Kristen. (2007). *Ham Radio's Technical Culture*. MIT Press, Cambridge, MA, USA.

Hippel, E. V. (2005). *Democratizing Innovation*. MIT Press, Cambridge, MA.

Horn, M and Jacob, R. (2007). "Tangible programming in the classroom with tern." In *CHI '07 Extended Abstracts on Human Factors in Computing Systems (CHI EA '07)*. ACM, New York, NY, USA, 1965-1970.

Huffman, J. (2015). "The electric notebook: an open source innovation to develop and engineering mind in children through making simple circuits, simple programming, and simple robots." *In Proceedings of Fablearn 2015*. Retrieved August 14, 2016, from <http://fablearn.stanford.edu/2015/wp-content/uploads/2015/10/FL2015-Demo-Huffman.pdf>

Jacoby, S. and Buechley, L. (2013). "Drawing the electric: storytelling with conductive ink." *In Proceedings of the 12th International Conference on Interaction Design and Children (IDC '13)*. ACM, New York, NY, USA, 265-268.

Johnson, S. and Thomas, A. P. (2010). "Squishy circuits: a tangible medium for electronics education." *In Proc. CHI EA '10*. ACM, New York, NY, USA, 4099-4104.

Karagozler, M., Poupyrev, I., Fedder, G. and Suzuki, Y. (2013). "Paper Generators: Harvesting Energy from Touching, Rubbing and Sliding." *Proc. User Interface Software and Technology Symposium (UIST)*.

Kawahara, Y., Hodges, S., Cook, B. S., Zhang, C. and Abowd, G. D. (2013). "Instant inkjet circuits: lab-based inkjet printing to support rapid prototyping of UbiComp devices." *In Proc. UbiComp '13*. ACM, New York, NY, USA, 363-372.

Kelleher, C. and Pausch, R. (2005). "Lowering the barriers to programming: A taxonomy of programming environments and languages for novice programmers." *ACM Comput. Surv.* 37, 2 (June 2005), 83-137.

Kim, J., Park, S., Jeong, T., Bae, M., Song, S., Lee, J., Han, I., Jung, D. and Yu, S. (2010). "Paper as a Substrate for Inorganic Powder Electroluminescence Devices." *IEEE Transactions on Electron Devices*. Vol 57 (6): p1470-1474.

Kim, S., Traille, A., Lee, H., Aubert, H., Kawahara, Y., Georgiadis, A., Collado, A. and Tentzeris, M. (2013). "Inkjet-printed Sensors on Paper Substrate for Agricultural Applications." *Proc. 43<sup>rd</sup> European Microwave Conference (EuMA)*.

Koehly, R., Curtil, D. and Wanderley, M. M. (2006) "Paper FSRs and latex/fabric traction sensors: methods for the development of home-made touch sensors." *In Proc. NIME '06. IRCAM — Centre Pompidou, Paris, France, 230-233*.

Kuo, Y., Verma, S., Schmid, T. and Dutta, P. (2010). "Hijacking power and bandwidth from the mobile phone's audio interface." *In Proceedings of the First ACM Symposium on Computing for Development (ACM DEV '10)*. ACM, New York, NY, USA, Article 24 , 10 pages.

- Lo, J. and Paulos, E. (2014). "ShrinkyCircuits: sketching, shrinking, and formgiving for electronic circuits." *In Proc. UIST '14*. ACM, New York, NY, USA, 291-299.
- Mackay, W. Pothier, G., Letondal, C., Bøegh, K. and Sørensen, H. (2002). "The missing link: augmenting biology laboratory notebooks." *In Proceedings of the 15th annual ACM symposium on User interface software and technology (UIST '02)*. ACM, New York, NY, USA, 41-50
- Maker Media. (2015). "Fact Sheet." Retrieved August 14, 2016, from <http://makermedia.com/press/fact-sheet/>.
- Martinez, S. and Stager G. (2013). *Invent to Learn: Making, Tinkering and Engineering in the Classroom*. Constructing Modern Knowledge Press, Torrance, CA, USA.
- Maxfield, C. (2011). "How It Was: PCB Layout from Rubylith to Dot and Tape to CAD." Retrieved August 14, 2016, from [http://www.eetimes.com/author.asp?section\\_id=14&doc\\_id=1285442](http://www.eetimes.com/author.asp?section_id=14&doc_id=1285442)
- May, K. (2001). "Conductive ink based page detection for linking digital and physical pages." *In CHI '01 Extended Abstracts on Human Factors in Computing Systems (CHI EA '01)*. ACM, New York, NY, USA, 275-276.
- Mcnerney, T. (2004) "From turtles to Tangible Programming Bricks: explorations in physical language design." *Personal and Ubiquitous Computing*. 8, 5, (Sept 2004), 326-337.
- Mellis, D. A., Jacoby, S., Buechley, L., Perner-Wilson, H. and Qi, J. (2013) "Microcontrollers as material: crafting circuits with paper, conductive ink, electronic components, and an 'untookit'." *In Proc of TEI '13*. ACM, New York, NY, USA, 83-90.
- Monache, S. D., Rocchesso, D., Qi, J., Buechley, L., Götzen, A. D. and Cestaro, D. (2012). "Paper mechanisms for sonic interaction." *In Proceedings of the Sixth International Conference on Tangible, Embedded and Embodied Interaction (TEI '12)*, Stephen N. Spencer (Ed.). ACM, New York, NY, USA, 61-68.
- National Science Foundation. (2010). *Employed scientists and engineers, by occupation, ethnicity, race, highest degree level, and sex: 2010 (updated)*. Retrieved August 11, 2016 from [http://www.nsf.gov/statistics/wmpd/2013/pdf/tab9-37\\_updated\\_2013\\_11.pdf](http://www.nsf.gov/statistics/wmpd/2013/pdf/tab9-37_updated_2013_11.pdf).
- Newton-Dunn, H., Nakano, H. and Gibson, J. (2003). "Block Jam: A Tangible Interface for Interactive Music." *In Proceedings of the 2003 conference on New interfaces for musical expression (NIME '03)*. National University of Singapore, Singapore, Singapore, 170-177.
- Ngai, S. (2005). "The Cuteness of the Avant-Garde." *Critical Inquiry* 31 University of Chicago Press, Chicago, IL, USA, 811-847.



- Oh, H. (2015). "From Papercraft to Paper Mechatronics: Exploring a New Medium and Developing a Computational Design Tool." In *Adjunct Proceedings of the 28th Annual ACM Symposium on User Interface Software & Technology (UIST '15 Adjunct)*. ACM, New York, NY, USA, 17-20.
- Oh, P. (2015). "Hack Your Notebook: Circuitry mixes with paper in a creative project for 21st century learners." *School Library Journal*, April 2015. Retrieved August 14, 2016, from <http://www.slj.com/2015/04/technology/hack-your-notebook-circuitry-mixes-with-paper-in-a-creative-project-for-21st-century-learners/>.
- Orth, M. (2001). *Sculpted Computational Objects with Smart and Active Computing Materials*. Ph.D. thesis.
- Papert, S. (1980). *Mindstorms*. Basic Books, New York, NY, USA.
- Perner-Wilson, H. (2011). *Kit-of-no-Parts*. M.S. thesis.
- Perner-Wilson, H., Buechley, L. and Satomi, M. (2010). "Handcrafting textile interfaces from a kit-of-no-parts." In *Proceedings of the fifth international conference on Tangible, embedded, and embodied interaction (TEI '11)*. ACM, New York, NY, USA, 61-68.
- Post, R., Orth, M., Russo, P. and Gershenfeld, N. (2000). "E-broidery: design and fabrication of textile-based computing." *IBM Systems Journal*, 39(3-4):840-860, 2000.
- Poupyrev, I., Gong, N., Fukuhara, S., Karagozler, M., Schwesig, C. and Robinson, K. (2016). "Project Jacquard: Interactive Digital Textiles at Scale." In *Proceedings of the 2016 CHI Conference on Human Factors in Computing Systems (CHI '16)*. ACM, New York, NY, USA, 4216-4227.
- Qi, J. (2012). *The Fine Art of Electronics: Paper-based Circuits for Creative Expression*. M.S. thesis.
- Qi, J. (2014). *The Circuit Sticker Sketchbook*. Studio Kosagi, Singapore.
- Qi, J. and Buechley, L. (2010). "Electronic popables: exploring paper-based computing through an interactive pop-up book." In *Proc TEI '10*. ACM, New York, NY, USA, 121-128.
- Qi, J. and Buechley, L. (2012). "Animating paper using shape memory alloys." In *Proceedings of the SIGCHI Conference on Human Factors in Computing Systems (CHI '12)*. ACM, New York, NY, USA, 749-752.
- Qi, J. and Buechley, L. (2014). "Sketching in circuits: designing and building electronics on paper." In *Proc CHI '14*. ACM, New York, NY, USA, 1713-1722.
- Raffle, H., Parkes, A. and Ishii, H. (2004). "Topobo: a constructive assembly system with kinetic memory." In *Proceedings of the SIGCHI Conference on Human Factors in Computing Systems (CHI '04)*. ACM, New York, NY, USA, 647-654.
- Ramakers, R., Todi, K. and Luyten, K. (2015). "PaperPulse: An Integrated Approach for

Embedding Electronics in Paper Designs.” In *Proceedings of the 33rd Annual ACM Conference on Human Factors in Computing Systems (CHI '15)*. ACM, New York, NY, USA, 2457-2466.

Resnick, M., Martin, F., Berg, R., Borovoy, R., Colella, V., Kramer, K., and Silverman, B. (1998) “Digital manipulatives: new toys to think with.” In *CHI '98*. ACM, New York, NY, USA, 281–287.

Resnick, M. and Silverman, B. (2005). “Some Reflections on Designing Construction Kits for Kids.” In *Proceedings of the 2005 conference on Interaction design and children (IDC '05)*. ACM, New York, NY, USA, 117-122.

Russo, A., Ahn, B. Y., Adams, J. J., Duoss, E.b. Bernhard, J. T. and Lewis, J. A. (2011). “Pen- on-paper flexible electronics.” *Advanced Materials*, pages 3426-3430.

Saul, G., Xu, C. and Gross, M. D. (2010). “Interactive paper devices: end-user design & fabrication.” In *Proc TEI '10*. ACM, New York, NY, USA, 205–212.

Schiller, F. (1967). *On the Aesthetic Education of Man*. Oxford University Press.

Shorter, M., Rogers, J., and McGhee, J. (2014). “Practical notes on paper circuits.” In *Proceedings of the 2014 conference on Designing interactive systems (DIS '14)*. ACM, New York, NY, USA, 483-492.

Siegel, A., Phillips, S., Wiley, B. and Whitesides, G. (2009). “Thin, Lightweight, Foldable Thermo-chromic Displays on Paper.” *Lab on a Chip*. Vol 9: p2775-2781.

Suzuki, H. and Kato, H. (1993). “AlgoBlock: a tangible programming language, a tool for collaborative learning.” In *Proc. 4<sup>th</sup> European Logo Conference*. Athens, Greece, 297-303.

Sylla, C., Branco, P., Gonçalves, S., Coutinho, C. and Brito, P. (2012). “t-books: merging traditional storybooks with electronics.” In *Proceedings of the 11th International Conference on Interaction Design and Children (IDC '12)*. ACM, New York, NY, USA, 323-326.

Tobjork, D., Osterbacka, R. (2011). “Paper Electronics.” *Advanced Materials*. Vol. 23, p1935-1961.

Turkle, S. and Papert, S. (1990). “Epistemological pluralism and the reevaluation of the concrete.” *SIGNS: Journal of Women in Culture and Society*. 16(1), 128--157.

Vallgård, A. and Redström, J. (2007). “Computational composites.” In *Proceedings of the SIGCHI Conference on Human Factors in Computing Systems (CHI '07)*. ACM, New York, NY, USA, 513-522.

Vogelsang, A. and Signer, B. (2005). “The lost cosmonaut: an interactive narrative environment on the basis of digitally enhanced paper.” In *Proceedings of the Third international conference on Virtual Storytelling: using virtual reality technologies for storytelling (ICVS'05)*, Gérard Subsol (Ed.). Springer-Verlag, Berlin, Heidelberg, 270-279.

White House. (2016). "Nation of Makers." Retrieved August 14, 2016, from <https://www.whitehouse.gov/nation-of-makers>.

World Bank Group. (2016). Primary Education, Teachers (% Female). Retrieved August 11, 2016, from <http://data.worldbank.org/indicator/SE.PRM.TCHR.FE.ZS>

World Bank Group. (2016). Secondary Education, Teachers (% Female). Retrieved August 11, 2016, from <http://data.worldbank.org/indicator/SE.SEC.TCHR.FE.ZS>

Wyeth, P. and Purchase, H. C. (2000). "Programming without a computer: A new interface for children under eight." *In the 1st Australasian User Interface Conference*, Canberra, Australia. 141–148.

Yamada, H. (2010). "SequenceBook: interactive paper book capable of changing the storylines by shuffling pages." *In CHI '10 Extended Abstracts on Human Factors in Computing Systems (CHI EA '10)*. ACM, New York, NY, USA, 4375-4380.

# Appendix A: Paper Curiosities

## ***PAPER CURIOSITIES: ARTIST CASE STUDIES***

Six artists were selected as case studies to see how expert creators would apply the paper electronics medium. The following section shares interview excerpts and passages from artists' online documentation to show in detail how artists conceived their ideas, their design and construction process and the final artwork.

Additional resources such as video are available at **[papercuriosities.media.mit.edu](http://papercuriosities.media.mit.edu)**.

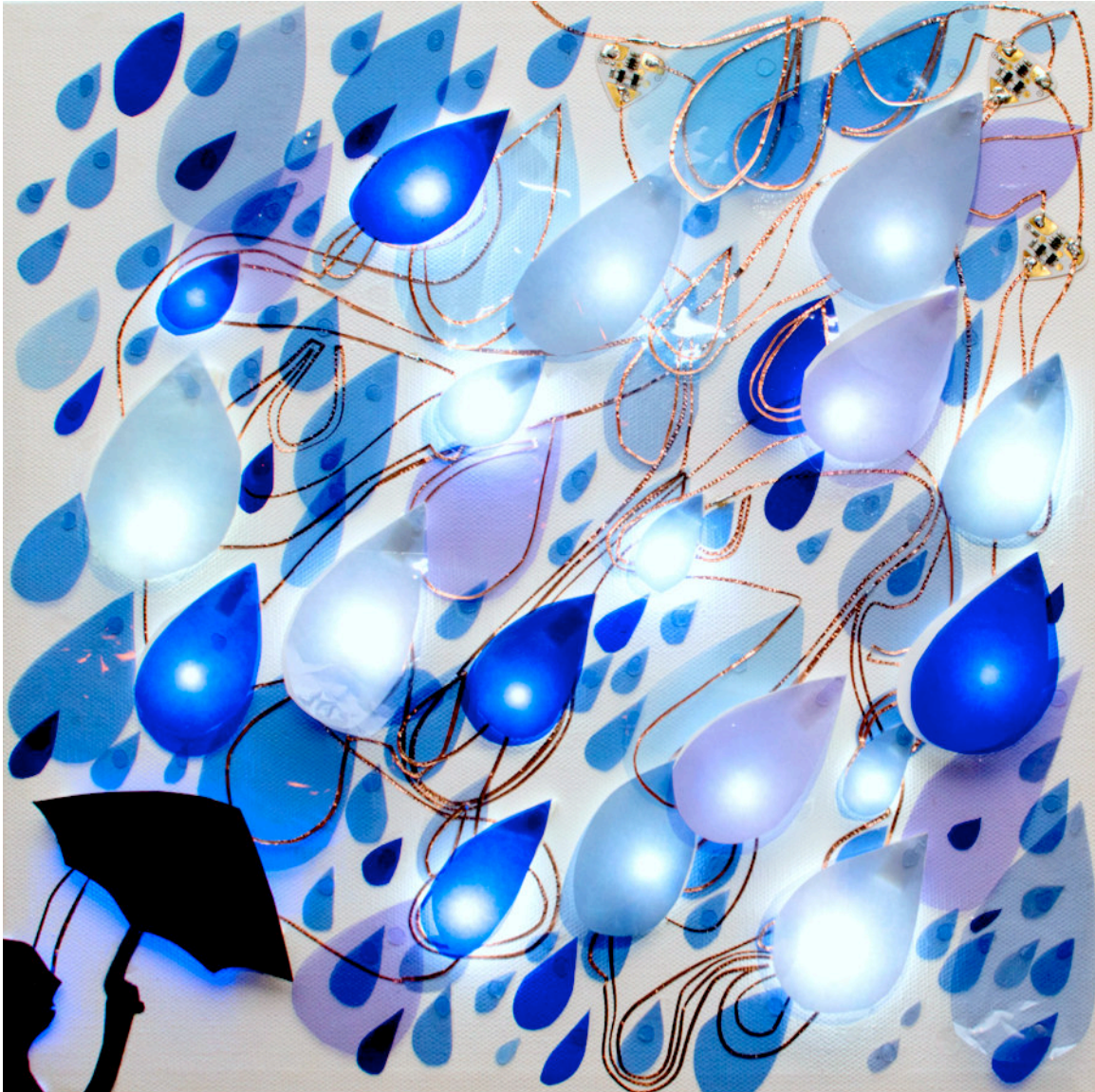

Figure A.1: *Curiosity of Rain* by Becca Rose

### ***Curiosity of Rain***

This piece captures the magical glistening of London's rain through flickering lights and translucent films. Lines of swirling circuitry tell the story of glowing raindrops swirling through the air on their way down to our world below. The person in the corner turns this piece into an illustration and adds a story. "What is that person doing? Where are they? Why are they in the rain?"

**Becca Rose** is a UK-based designer and educator. She works with a variety of mediums at the intersection of folk art and crafts with science and technology.

***beccarose.co.uk***

## Concept

*The story and theme for Curiosity of Rain emerged out of the exploration process described below.*

## Process

“I wanted to start something so I made a blank book for making experiments.”

“Where is my starting point—that’s hard. It’s a bit scary going to the big piece so I’m going to explore further first... The book has multiple tiles so you can explore. You can do a page and if you don’t like it, you can turn the page over and do another page. I wanted something that could have a kind of linear story from beginning to finish. Each page leads to the next, and each page is a step that punctuates the design and ideation process. It provides a structure to the development process.

“I’m constantly doodling or making marks in pen, I love drawing, so I’m just going to make marks with copper tape without thinking about it too much. I started cutting up tape and then switched to pen ... going back and forth almost like a conversation between inks and conductive materials. Then I made some lights—just used them and wasn’t thinking too much, initially. Underneath there’s another pattern. These are patterns that I normally draw on books.

“I also draw eyes a lot as a motif so I started drawing some eyes. Eyes are quite expressive... I don’t know how but really interested to work out this animated eye effect, like there is a character in this drawing. I’m imagining all these eyes, hoping it can respond to light and come alive. (*Figure A.2*).

“When playing around in the book I started layering see-through cellophane gels. It had been raining for weeks on end and the pieces looked to me like raindrops. As soon as I did the first droplet in the book, I realized ‘oh that’s it I’m done’ and moved on to the final piece. I just needed that place to explore. (*Figure A.3 top*)

On the final canvas, “the circuitry part began as abstract forms and I was just playing and doing a pattern [Figure A.4]. A big turning point was when I added a person in the corner, turning it into an illustration. Making it into a story was really satisfying. (*Figure A.1*)

After finishing the piece “I actually went back to the book and added some more pages to the end because I wanted to have that feeling of completion of ideas.” (*Figure A.3 bottom*).



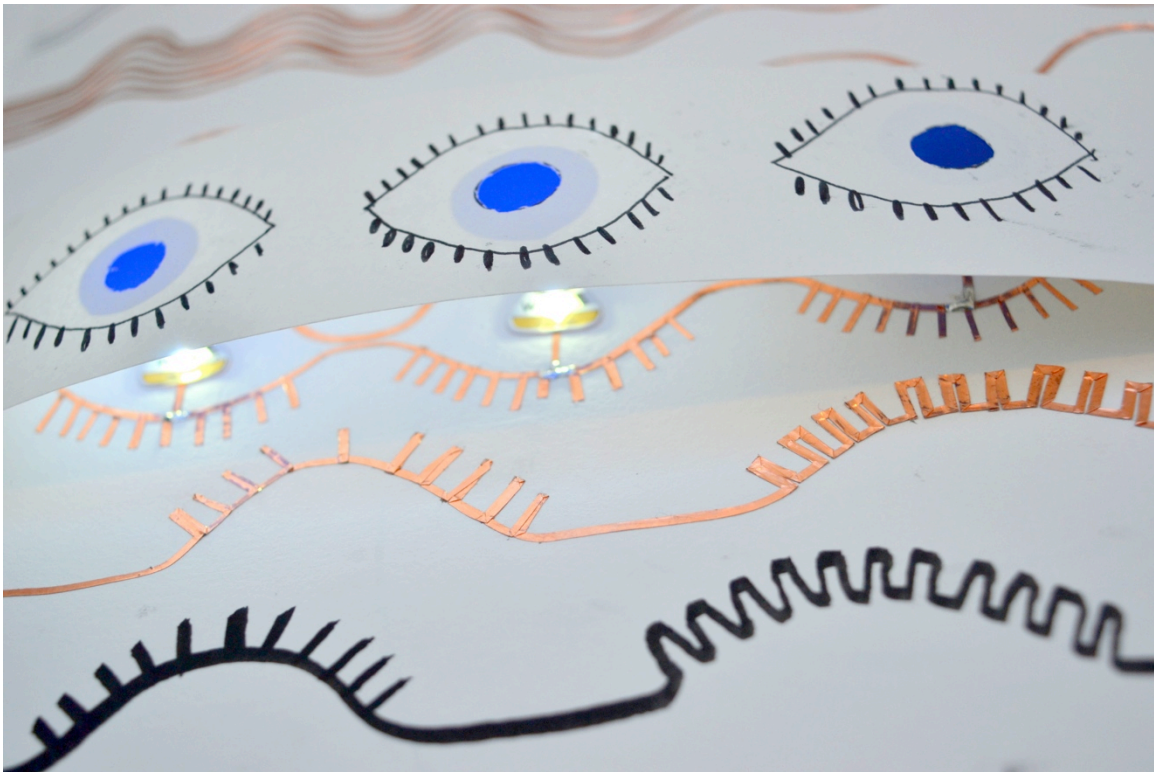
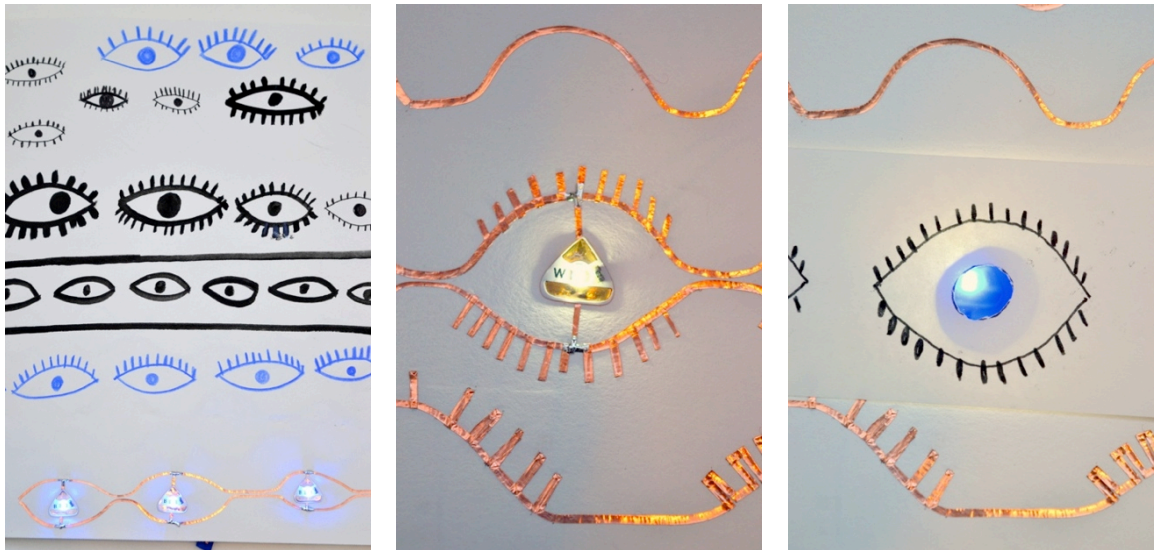

Figure A.2: Book Explorations for *Curiosity of Rain* by Becca Rose



Figure A.3: Book Explorations for *Curiosity of Rain* (continued) by Becca Rose



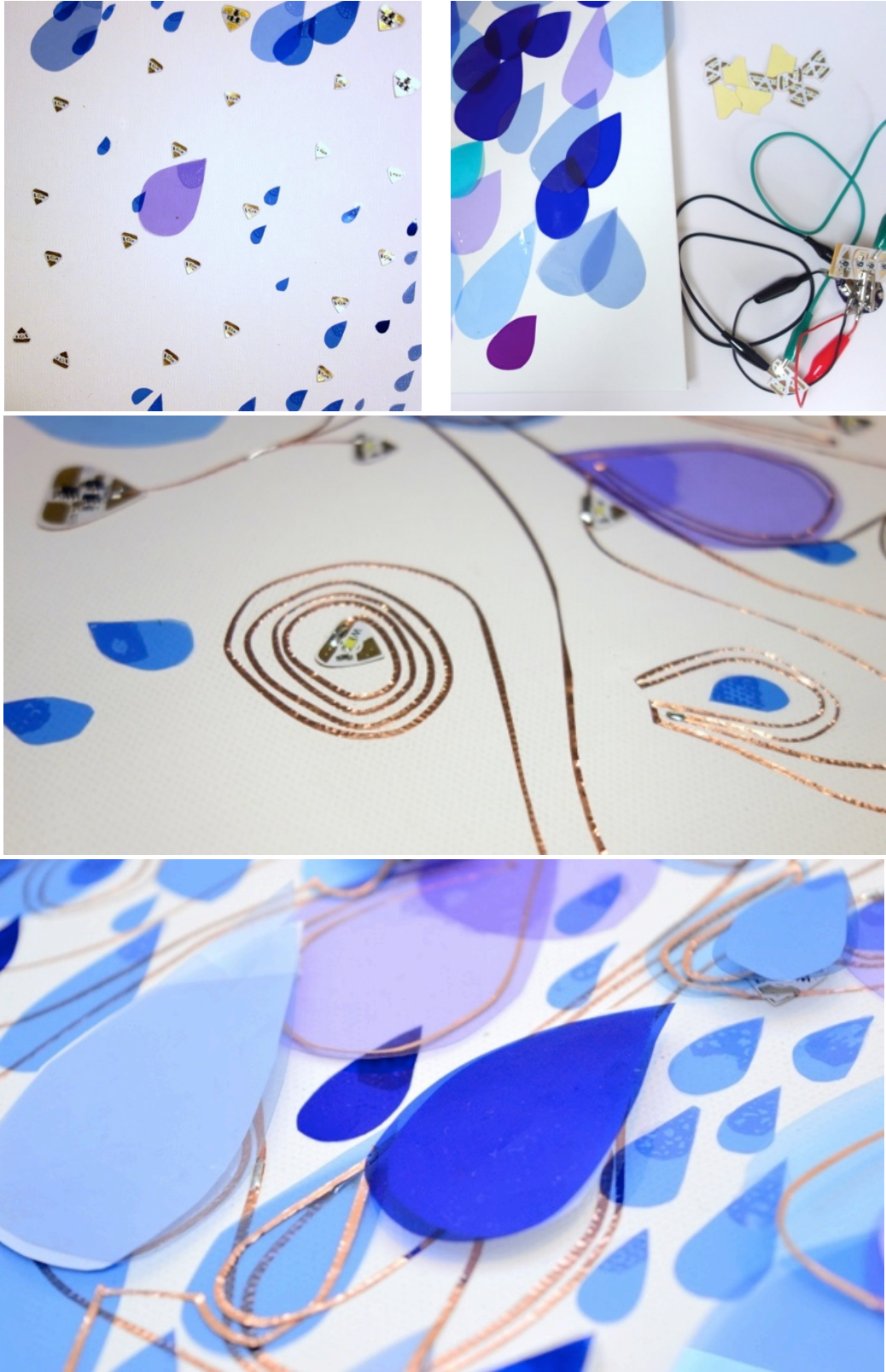

Figure A.4: *Curiosity of Rain* construction process by Becca Rose.

## *Outcome & Insights*

“I’ve never made something this way before. I’ve used copper tape but never done anything so elaborate. Layering this way and having effects switch was quite nice. I don’t have fiddle around with [programming an] attiny since it’s just done. I can just have fun making the circuits and the actual illustrations.

“Something I hadn’t thought about before was using these [conductive] materials for mark making. I had seen it before in conductive paint. It’s interesting that it forces you to work in a slight different way and make marks in a slightly different way because of how the material works... I got out the bone folder to flatten the copper and then was able to do curves. It was much freer and much more fun. It feels like a stroke, like a brush stroke. And the way you can stretch it and pull it, to make the movement at the same time, is really satisfying.

“I would’ve liked to add more interactivity—the effects are already interactive with time—but it would’ve been more complex and I purposely set up limitations. I started the project trying to be limited because I know if you try to do everything, you don’t do anything. I wanted to add a convenient on/off switch but did not have time. I was afraid that a switch made of paper would not be robust enough.

“Doing the elaborate things with the circuitry I might not have done it that way again and try to simplify. On the one hand you could be playful with the circuitry and the way it looks and incorporate that into the illustration and on other hand not have this crazy undebuggable circuitry that could break at any moment! It would be good to have a balance of these.

“This process [for making this piece] was quite different because normally I don’t feel so indulgent to just get to explore. Often stuff I do has some overriding idea or it’s for a workshop—there’s something weighing on it. This was really fun because it’s a lot about the material. My favorite part was the openness and how it felt luxurious and non-pressured. I need that exploratory process with material ... I can’t just make the [final] thing. I look back from a distance and suddenly there is a narrative thread that connects everything. The results emerge from playing.”

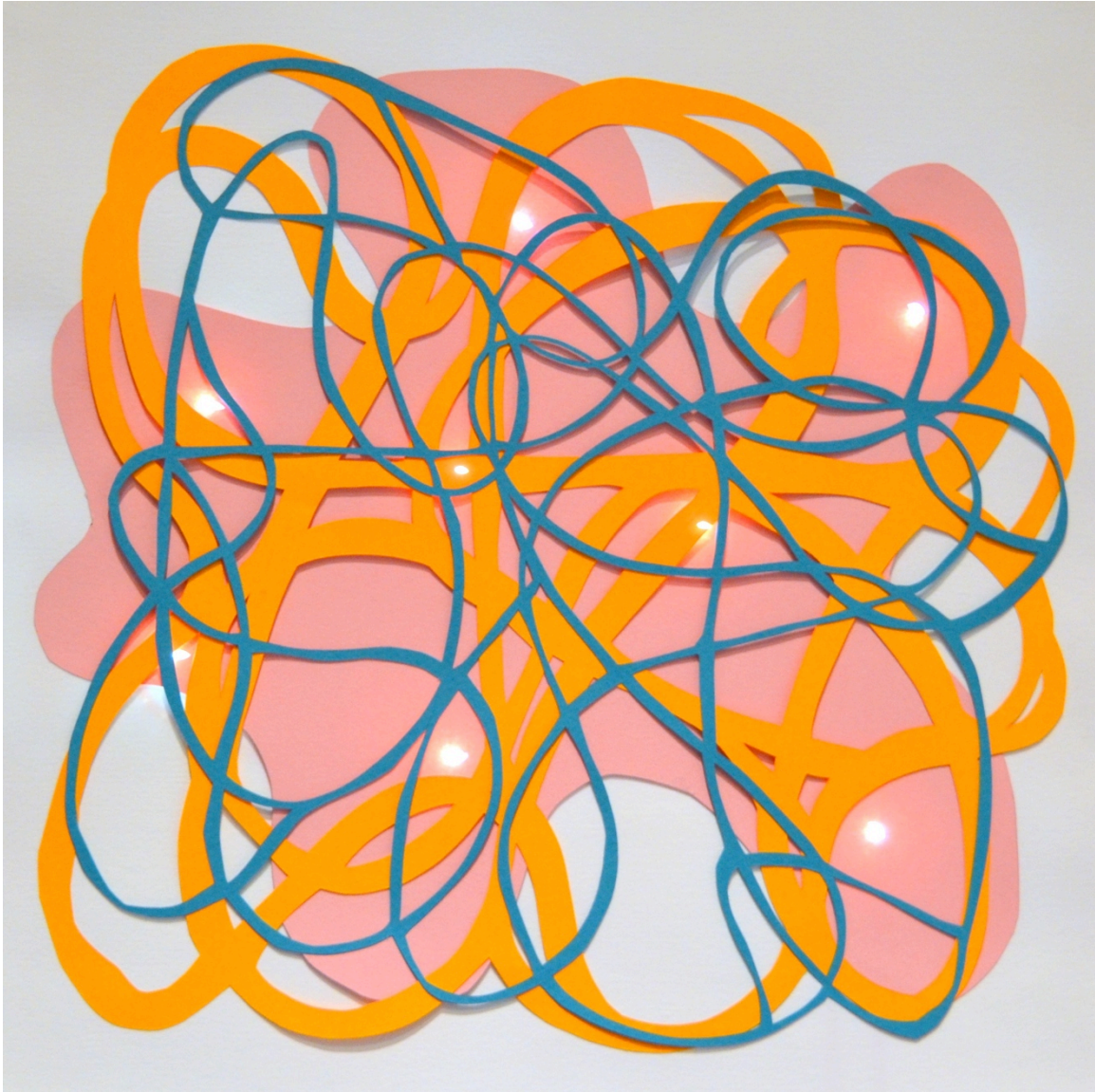

Figure A.5: *Twinkling Stars Inside Stomach* by Sara Mallory

### ***Twinkling Stars Inside Stomach***

“*Twinkling Stars Inside Stomach* was a kind of a playful feeling image. It’s kind of a play on an expression I heard once describing someone that has some sort of extra special ‘inside energy.’ The universe is vast and a little mysterious. Maybe so are the insides of our bodies.”

**Sarah Mallory** is a Brooklyn-based paper and book artist. She creates delicate illustrations and portraits by layering hand-cut paper, occasionally incorporating other materials like sewn thread through paper.

***sarahmallorystudio.com***

## Concept

“My artwork right now is very concerned with emotional associations with the body. Like if you’re feeling nervous that’s often a stomach thing or if you’re heartbroken– that’s also an organ connotation with an abstract thought or emotional response... I think of this piece more as a concept draft. It is playful but also literal in material to concept translation since this time there is actually a light source.”

## Process

*This artist began with pencil sketches on paper of the final shapes and then hand cut the paper based on the sketched patterns. Then she sketched out her circuit to have lights correspond to these shapes and created a lower layer for the circuitry. However, she connected the LEDs in a series circuit configuration, so they could not be powered with the USB power supply provided (Figure A.6).*

“I did some tests in smaller scale. I did your notebook [the Circuit Sketchbook] and tried out some types of circuits in that. Then I did some circuits on cut paper with a couple lights and so I didn’t realize you couldn’t just keep adding more. This is new territory and so much out of my comfort zone.”

*With permission from the artist, I adjusted the circuit connections so that the LEDs were connected in parallel and could turn on with the given power supply.*



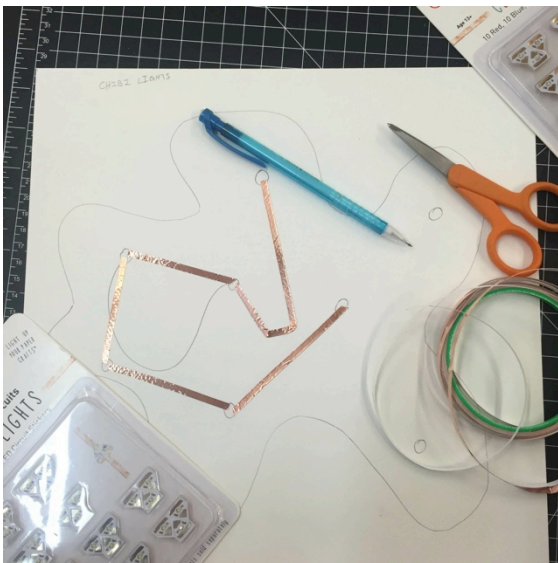
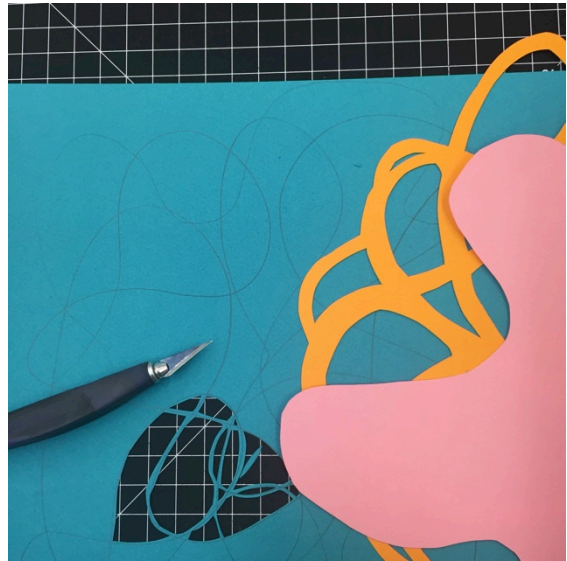

**Figure A.6: *Twinkling Lights inside Stomach* construction process by Sara Mallory**

## *Outcome & Insights*

*Asked whether this work authentically reflects her creative practice, the artist responded,* “Yes because it looks like my work with lights behind it. It looks like I made it.”

“I come from a materials conscious background where you come up with a concept and whatever material is appropriate for the concept is what you use. This [circuit] material has other connotations, simply from being a form of technology. Technology needs to be very appropriate for the concept.

“Rather than figuring out how the material can transform to aid the concept, with this [circuit] material I didn’t need to think about manipulation. I just needed to think about incorporating. The materials are already set and ready to go. You can manipulate how the materials are arranged, but you can’t manipulate them so much. It’s almost like a readymade where you’re collaging. Initially I thought this would be easier but it was different from how I normally approach material, so it was a different process. It’s not how my brain approaches artwork

“I really like working with paper and how hard you have to work to get it to do what you want. I like the evidence of hand-labored surfaces that come out of this. Most of my pieces are pretty intricate and detailed—lots of little cuts which are a lot of labor and the pieces are evidence and record of that.

“Having multiple layers in a piece is not new for me but I’ve never worked with a hidden [circuit] layer before. Normally anything hidden is just the back side, but this has an interior, which is different. [Circuitry] is not part of any aesthetic I’m familiar with and the paper layers on the front are. So the lights will come through the back and that’s what I stuck with.

“I didn’t think about this before, but maybe this hidden [aspect of the] layer is actually a counter to my interior technology layer because you can’t see the work. Having evidence of how much work went into the piece is really important. I’m used to showing how much work went into creating my pieces, but due to the [circuit] layer being hidden, you can’t tell. As a result, I was less interested in this layer. But I think if I were to do it again, I would try for that to make the circuit an exposed layer.”



Figure A.7: *Tickytown* by K-Fai Steele

### ***Tickytown* by K-Fai Steele**

*Tickytown*, a paper circuit project that's a play on Richard Scarry's *Busytown*, and also inspired by Siennese early Renaissance painting. This overwhelmed terrier mutt has been overrun by ticks, forming the city of *Tickytown* on its back! Find out what these little creatures are up to by petting the dog.

**K-Fai Steele** is a San Francisco-based educator and children's book illustrator. She specializes in humorous and whimsical illustrations done with ink and watercolor.  
***k-faisteele.com***



## Concept

“When thinking of project, I made list of all these things that light up and was thinking a lot about Richard Scary at the time. I’m always thinking about children’s books and picture books. From traveling and staying in places with great views of cities, I’ve been drawing a lot of cities and thinking about life in cities. I was reminded of a Far Side cartoon of a landscape painting where the trees turn out to be fur. So came the idea of a dog so plagued by ticks that they grew a city on its back.

“I was also inspired by the dandelion painting and how magic happens in the interaction. How can I have a simple interaction enhance a complex story? I don’t want you to see it, then get it and move on. The content is the thing that will get someone to stay in front of it. I want something to have a lot of stuff for you to look at. The story element does this.”

## Process

*The following process documentation is an abbreviated version of the original account from the artist’s website.*<sup>66</sup>

“I’m starting off with a simple idea: a slide switch to make a bunch of LEDs go on or off. And I want the drawing to be able to reveal something that you otherwise wouldn’t see so I’ve been playing around with materials (mylar, acetate) to test levels of transparency.

“I’ve found so far that mylar doesn’t work as well as I’d hoped in terms of transparency (I think I’d have to use like 10mm “super bright” LEDs or something). Maybe I can figure out a way to make it work, because that would be so lovely to have a mirror reveal an image when illuminated. The smoky/violet toned acetate when doubled seems to hide enough, and if I have a ton of things happening in the drawing this should work. Also I like how the size of the LED matches the size that a single naked bulb hanging from a ceiling would appear in a window. It adds to the narrative, and in this case, is a little depressing or “real”? Which I like.

“The narrative is going to be fun, inspired by a combination of Busytown and Far Side cartoons, and is about ticks, which I realize is really gross when I describe it in words and not drawings. Here’s a sketch of one that’s taking a shower. The light isn’t in the right spot but I think I got his expression of shock (Figure A.8, top).”<sup>67</sup>

---

<sup>66</sup> <http://www.k-faisteele.com/>

<sup>67</sup> <http://k-faisteele.com/2015/10/26/ticky-town-beginnings/>

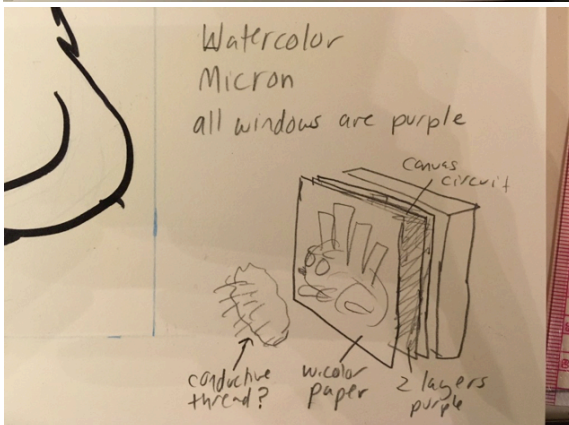
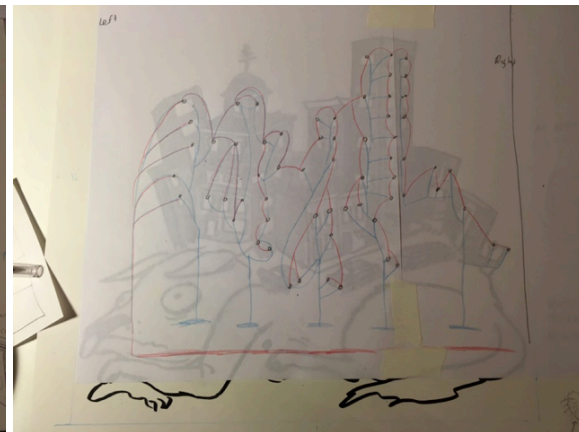
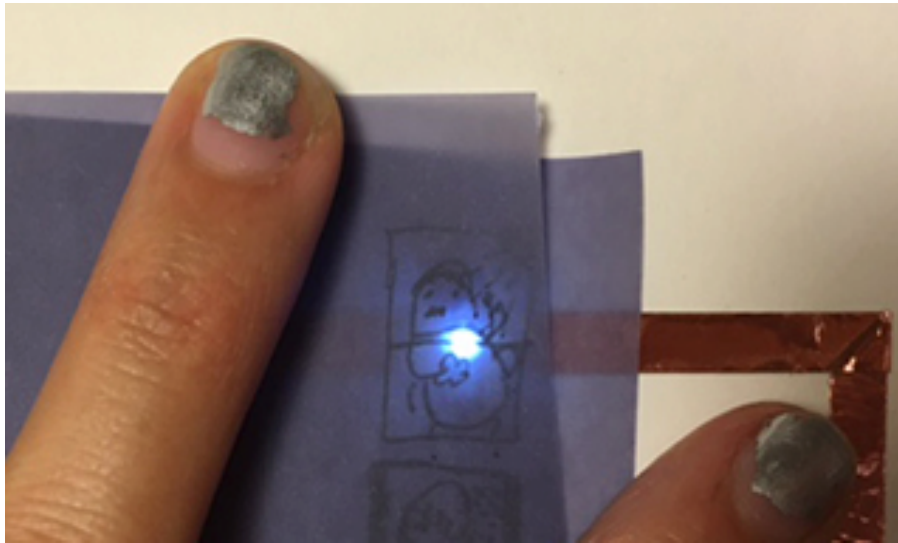

Figure A.8: Vellum and light test (top). Circuit sketches and prototype (middle and bottom) for *Tickytown* by K-Fai Steele

*Process (continued)*

“Right now it’s looking like the hardest part is going to be mapping out all of the LEDs (though that is sort of fun and satisfying). Maybe more difficult will be figuring out the capacitive touch stuff, if I want to fool around with conductive thread and/or fabric, etc. Really looking forward to building all the stories within the city.”<sup>68</sup>

“I’ve been fooling around trying to figure out how the interactivity is going to work with the lights and citizens of TickyTown. I drew out the circuit, and although I felt like my brain was turning inside out when I was making it, it seems like it’s going to work on paper (Figure A.8 center and bottom left). I’m thinking about how to make the viewer want to pet the dog, and I think I’m going to have to have hair or fur or something to invite that interaction. Thinking about incorporating Hannah Perner-Wilson’s stroke sensor, but putting it through a piece of thin leather from a hide I bought in Argentina a few years ago as opposed to neoprene, which feels less ‘doggy.’”<sup>69</sup>

“Designing an idea is easy enough on paper (“I want to make a dog that lights up a city of ticks on its back when you pet it”) but the exciting (and frustrating) work happens for me when I try to make it actually happen. Typically I’ll just be impulsive and bold: try to make the whole thing at once, no prototyping. This fast and loose style gets me far in drawing and painting, but when it comes to assembling circuits it usually ends up in frustration and half-finished products. So this time I went more slowly and made a prototype of a fur patch and a circuit with 4 LEDs (Figure A.8, bottom, right).

“The whole thing so far feels pretty Frankenstein-y; the fur switch has a piece of copper tape on it, and I sewed that on with conductive thread. The idea is that when you press the fur, the lights flicker across the city.

“But once I made it I realized that the whole circuit would eventually be connected from what I’m assuming will be many hands pressing down on it. So it wouldn’t really be a switch at that point, and would lose all interactivity, which I see as central to the piece. So I put a piece of velostat over the switch, so that the harder you press it, the less resistant it is.”<sup>70</sup>

---

<sup>68</sup> Steele, K. (2015). *Ticky-town Beginnings*. <http://k-faisteele.com/2015/10/26/ticky-town-beginnings/>

<sup>69</sup> Plusea. (2009). *Stroke Sensor*. <http://www.instructables.com/id/Stroke-Sensor/>

<sup>70</sup> Steele, K. (2015). *The Realness of the Circuit*. <http://k-faisteele.com/2015/11/29/the-realness-of-the-circuit/>

*Process (continued)*

“I approached the physical construction of this piece initially in what turned out to be a backwards way that wasn’t working for me; I was trying to start with the drawing as opposed to the circuit. I soon realized my drawing wouldn’t line up with the LEDs underneath. It’d be off register because I’d be constantly flipping it up and down and guessing where the LEDs would go. So I had to make the circuit first, because it’s easier for me to erase something in pencil than it is for me to unstick and restick a copper tape circuit. It took a lot of time. But I did it all, with no copper tape cuts.

“After I laid down all the copper tape, I put the Circuit stickers on top. But once I started to solder it I realized that I needed to have copper tape on top of the circuit sticker in order to make a good solder connection. So I had to go back in and put little bits of copper tape at the ends of each circuit sticker. I think I used like 28 stickers. Once that was done I noticed that I’d have to solder every point where I tore the copper tape. And that the copper tape really needed to be flush with the circuit sticker, otherwise after soldering it would just peel up, so I used a bone folder to press each connection down. Music made this go by faster, but it took a long time and was pretty tedious by the end. (Figure A.9).

“Generally I tend to begin my more technology-focused projects by starting with art, then adding interactive elements. But in this case they had to happen sort of at the same time – plan the idea, try to figure out ways to make it a reality, then plan out the design of both the art and the circuit and put it all together.

“Challenge: the circuit was pretty complex. I couldn’t believe how strong the connection was (and how bright the LEDs got) once I soldered the connections. I was thinking about all the times I’d run workshops with librarians and kids and their LED wouldn’t light up because of connection problems. And it’s challenging to bring soldering irons into libraries/around kids. So this is one area where I think circuit stickers could be (somehow?) improved – to make it less challenging to be able to light up a bunch of LEDs, or even a couple of LEDs without having to fuss with pressing copper tape down, etc. I’m pretty happy with how the circuit came out though.”<sup>71</sup>

---

<sup>71</sup> Steele, K. (2015). *The Circuit Emerges*. <http://k-faisteel.com/2015/12/11/the-circuit-emerges/>

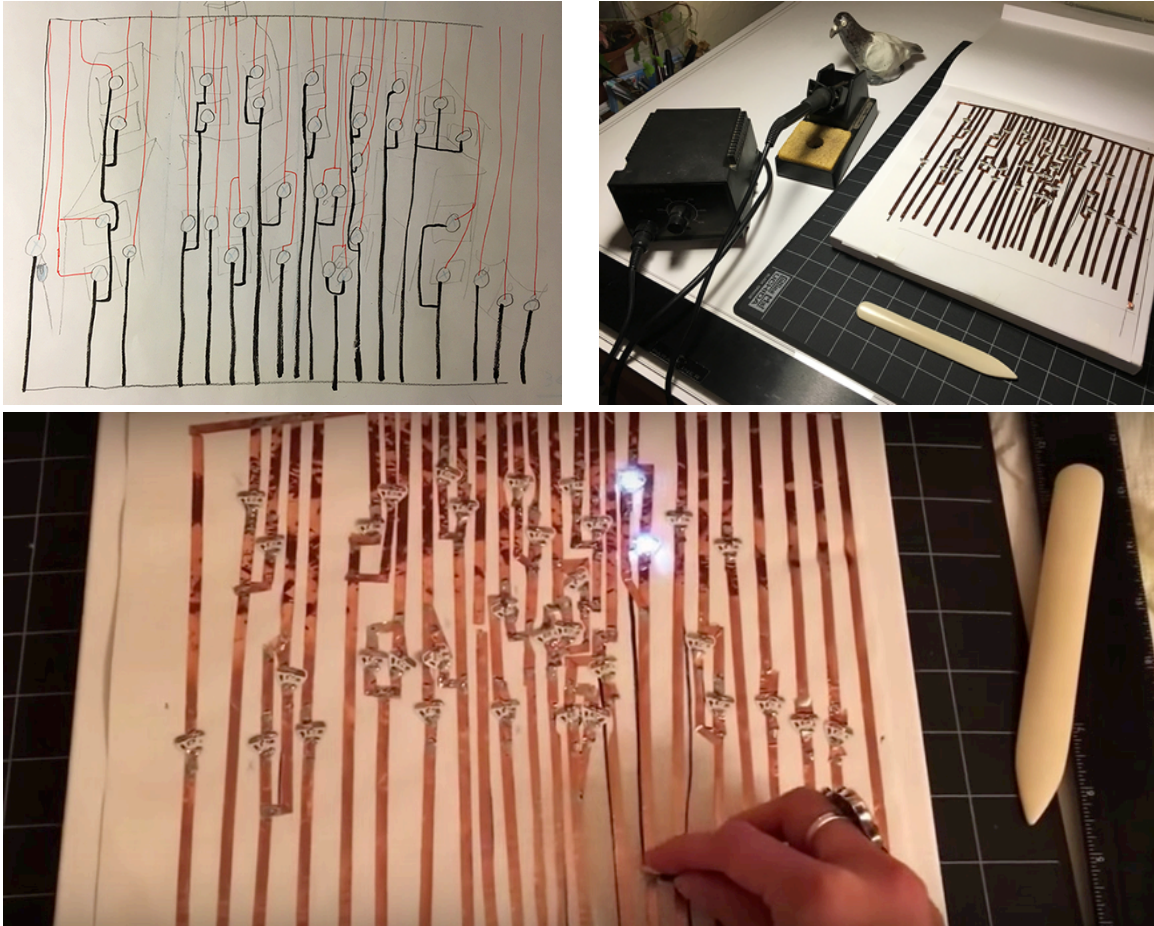

Figure A.9: *TickyTown* final construction sketch (upper left), soldered LEDs (upper right) and circuit test (bottom) by K-Fai Steele

## *Process (continued)*

“Now that the circuit is done, I’ve been working on building up the structure for the “narrative.” It’s basically a sandwich of different kinds of paper, then the actual dog switch on top of it all. I wanted the windows to have the illusion of being dark, then illuminated when you pressed the dog, so there are 2 layers of purple-y vellum, with the ink drawing on the bottom level. I cut out that part in the middle because that’s where the streetlights/car lights will be, and the LEDs don’t really shine through 3 layers that well. (*Figure A.10, top*).

“And then there’s the drawing that sits on top of it all, with a cutaway at the bottom to expose the copper tape – where the dog touches the rest of the circuit. I put a big piece of Velostat between the dog and the switch, because I realized with repeated petting the dog might just stay “on” all the time. Also, it creates a nice effect with the LEDs growing brighter as you pet harder. (*Figure A.10, bottom*).

“The process of putting together this sandwich was a lot faster than the circuit planning, building, and soldering process. I spent way more time sort of agonizing if I’d be able to make it happen. Once I came up with a plan that I thought would work, and a prototype, things moved along really fast. I draw really fast, and boldly. I didn’t pencil any of the drawings of the “interiors” first because I didn’t want to deal with erasing the pencil lines afterwards. I went right in with my brush pen. This worked out really well for the most part, but there’s one window where you really sort of can’t tell what’s going on.

“I’m concerned about the piece’s resiliency. I didn’t spend as much time thinking about/designing how the whole thing would hold together over time. A previous job of mine was in art handling and conservation, and this piece is connected to the canvas by white artist tape. The dog is connected with magnets; three taped to the back of the canvas, and three sewn into the back of the dog switch. I wish I had designed a way so that someone could lift it up, look at the insides, then put it all back together easily... If I had designed this thing to have some sensor other than touch (like sound, light) it would hold up better, but I wanted to make a piece that’s “thing” wasn’t so dependent on the light and sound levels of the space it was in.

“Overall I’m happy with how it came out. I spent about maybe three and a half months planning it, then putting it together.”<sup>72</sup> (*Figure A.10, upper right*).

---

<sup>72</sup> Steele, K. (2015). *Tickytown Construction Continues*. <http://k-faisteele.com/2016/01/14/tickytown-construction-continues/>





Figure A.10: *TickyTown* final construction process: vellum overlay (upper left), textile tog (upper right) and Velostat pressure sensor (bottom). Images by K-Fai Steele



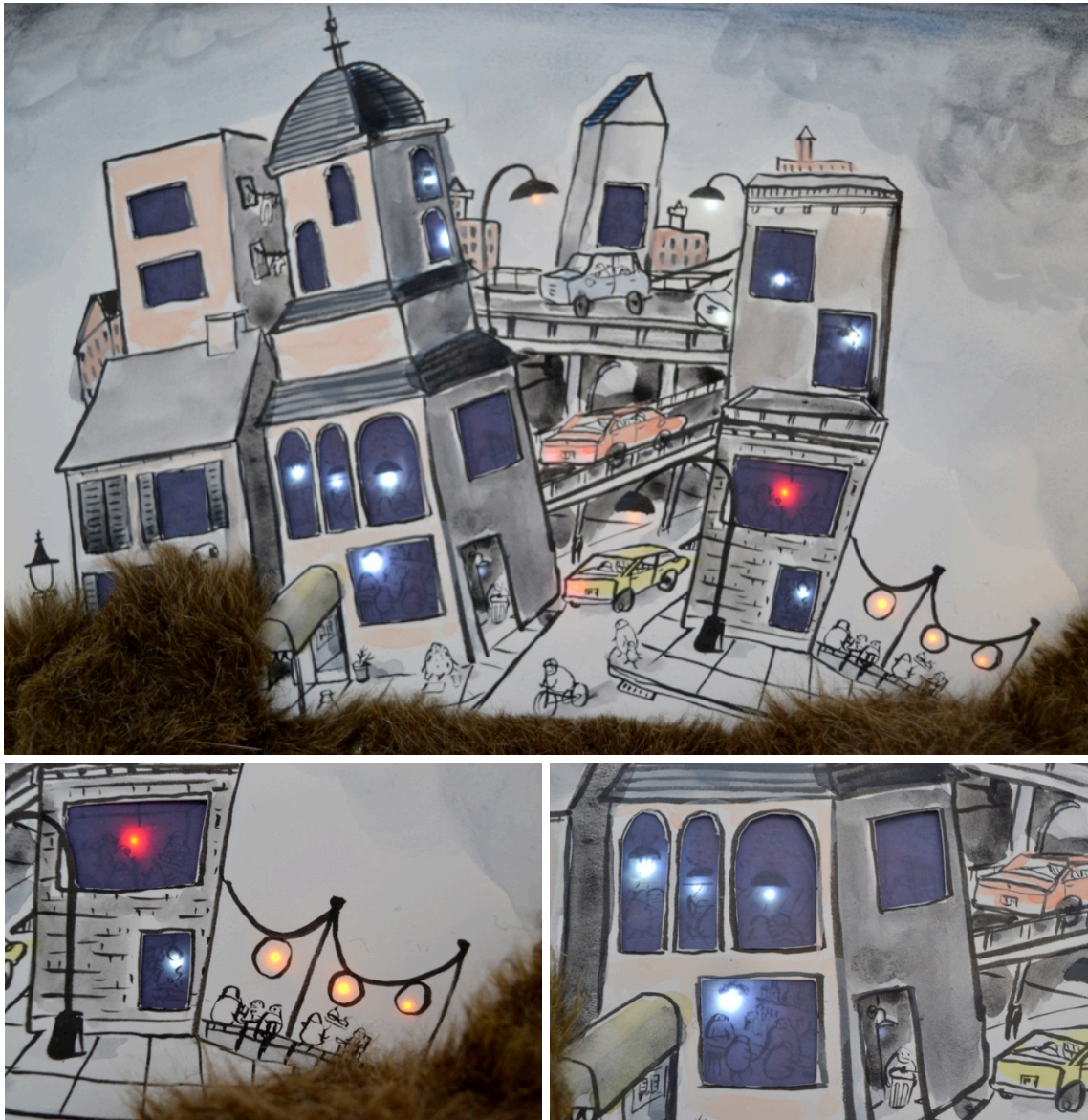

Figure A.11: Details from *TickyTown* final by K-Fai Steele

## *Outcomes & Insights*

“My creative process tends to be very fast and I like that immediate gratification. Maybe that’s why I like paper circuits too—you can just put it down. The problem with planning and prototyping is you have different momentum. I want to just get things on paper but need to plan [for things to work]. Instead of working with one surface, now I’m working with many layers—how do I coordinate the sandwich: canvas, tape and circuit, vellum, drawing and fur?”

“I kept on putting off putting circuit things and when I actually came around, it wasn’t that difficult. Once we did our video chat, and went through the [circuit] drawing together, I realized it was way more complex in my head than it needed to be.

“I had anticipated that drawing would be most fun because that is where I typically find more enjoyment. But this time I put the lights randomly on, before drawing the story. Just making the circuit was really fun and once it worked I thought ‘this is amazing!’ It was pretty magical that it’s working at all and only took a night. Once I powered it up and was able to play, I thought ‘this is already working’ and ‘this is already enough.’ Drawing on top was still fun but putting together the circuitry was special and super rewarding. I hadn’t ever made something so complicated before!

“I’m not an expert but I’m comfortable with learning. I feel a bit of an outside going into this world, but like that there is space for ‘I do do art really well and I can learn.’

“What’s exciting to me is that I see [paper circuits] as another tool or material in my toolbox and it’s not something I’m scare of. I have paper, pencil and paper circuits. I will definitely play with it again in the future when it seems right. For example, I would love to figure out a way to make books with this. Imagine an entire book with interactive elements like the dandelion painting or the dog!”



Figure A.12: *Untitled* by Yael Friedman

### ***Untitled***

*Untitled* is a pendant necklace made of paper, an LED and a 3D printed back plate. This piece explores light as a material to accentuate the textures and folds of the origami form.

**Yael Friedman** is an Israeli artist and jewelry designer. Her jewelry is known for their mechanical complexity, inviting wearers to play with moving parts like puzzle pieces. These pieces are often fabricated through 3D printing processes.

***yayo-design.com***

## Concept

“I’m a jewelry designer and usually I work with many teeny tiny moving parts that are also part of a puzzle. Since I’m usually doing really complex things, I find this project to be very simple.

“When I did this [origami] since you see all the folding, it creates something nice and more interesting for me. The light for this one can be nice because makes the folds more noticeable—it’s a way to see the creases of the origami better. I put the light inside and it looks very majestic. It’s not complex, but I like it, which is important. For me it makes sense to use light in this one.”

## Process

*This artist began by creating various jewelry prototypes to try out techniques with copper tape, paper and light (Figures A.13, A.14 and A.15, upper left and middle). The main challenge was to find an application of light that made sense in the context of jewelry.*

“The one with the copper tape [designs]... once I added the light it didn’t make sense. Some might say ‘wow this looks amazing.’ It was fun to make but it’s not me.

“At the beginning thought it would be really nice to be able to switch the color so once you have a white necklace and then a red one and then a blue one... And then it wasn’t interesting anymore. I was like why? So I stopped at the white. So if I’m sticking with white, let’s find something that looks different when it’s off then when it’s on.”

“I made a ball of papier-mâché over aluminum and cut out the aluminum ball. I bought a soldering iron so I can play at home. I stripped the wire in certain places and soldered LEDs there. Then I connected the [hollow] ball back together with the circuit inside.”  
*This prototype had symbols embedded in the papier-mâché that only became visible when the light illuminated from inside (Figure A.14).*

“To do all those light pictures—you have layers of paper and light behind it—it’s not me. I could sit and do it but it’s not something I’m particularly excited about. I have to be proud of what I’m doing. Otherwise I don’t like to share. Then I started playing with origami and thought hmm this looked nice. I’m proud of this one, maybe it’s because of the paper and the folding. [Adding light] makes it more interesting because you have bright light in these parts and where the folds are.” (Figure A.15, upper right and bottom).





Figure A.13: Jewelry prototypes with copper tape pattern by Yael Friedman



Figure A.14: Jewelry prototypes with illuminated paper-mâché beads with backlit patterns by Yael Freidman. Open bead with exposed LED circuitry inside (lower right).



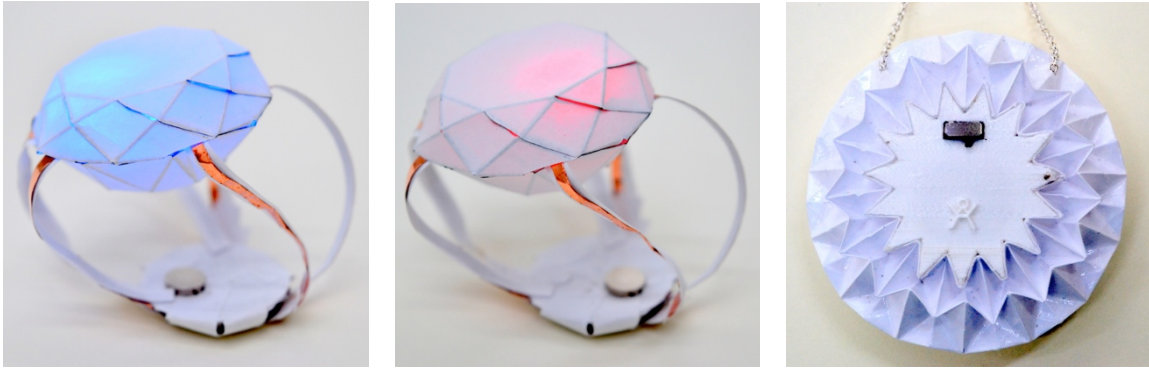

Figure A.15: Origami jewelry prototypes (upper left and center) and final pendant (upper right and bottom) by Yael Friedman



## *Outcomes & Insights*

“Typically I have an idea and I make it. I usually go directly to the final materials. The sketch is only in my head. Once I put it down on paper, I don’t do it anymore because it’s already out here—weird I know.

“Working with paper circuits was similar in that I suddenly have an idea and it works. I didn’t know anything about electricity before and the book and kit were really nice for understanding basics. Once you told me how things are supposed to be connected, I know how to connect them. It’s like 3D modeling complex designs: once I know the connections and how things need to fit, the rest is free and clear.

“Working with many materials like plastic, paper, leather is not a problem. But taking light and putting it in something is not something I will do, because I struggled to make sense of the combination. The first thing I made had just copper and it looked nice but then I had to put in the light and the light didn’t make sense. Then I iterated until I finally found a case for the light.

“My struggle was not in learning how to do it, but combining it in a piece of jewelry that made sense. The difference is that usually I’m not making that many prototypes before I know what I want to do. Usually I know and I just create.

“I thought that I would be more interested in creating all kinds of blinking lights but then I realized no. You gave me all kinds of complex things and I think ‘but why do I need the light to blink?’ For myself and for my jewelry. It’s great to have all kinds of circuits but there’s no reason for me to use those complex circuit because why should it blink? Usually when I design things, there’s a purpose. I did all this work and it looks beautiful but is this enough? It makes it brighter but is this enough?

“My interests are very specific, I don’t get excited about everything. Once I realized how things worked it didn’t seem that interesting anymore. I don’t like light—it’s something I did not know before. I was really excited at the beginning I had all these crazy things going on. I can do this... I can do this... but then I realized that none of the things I thought of made any sense. It was fun to learn but I will not use it in my jewelry.

“In the future, I might use motors for movement, but not light. I’m also now experimenting with shape memory actuators on some designs. My pieces are normally mechanical—they use cranks, etc.—but it’s not automatic. With a motor, it could be interesting since it adds to these existing mechanisms.”

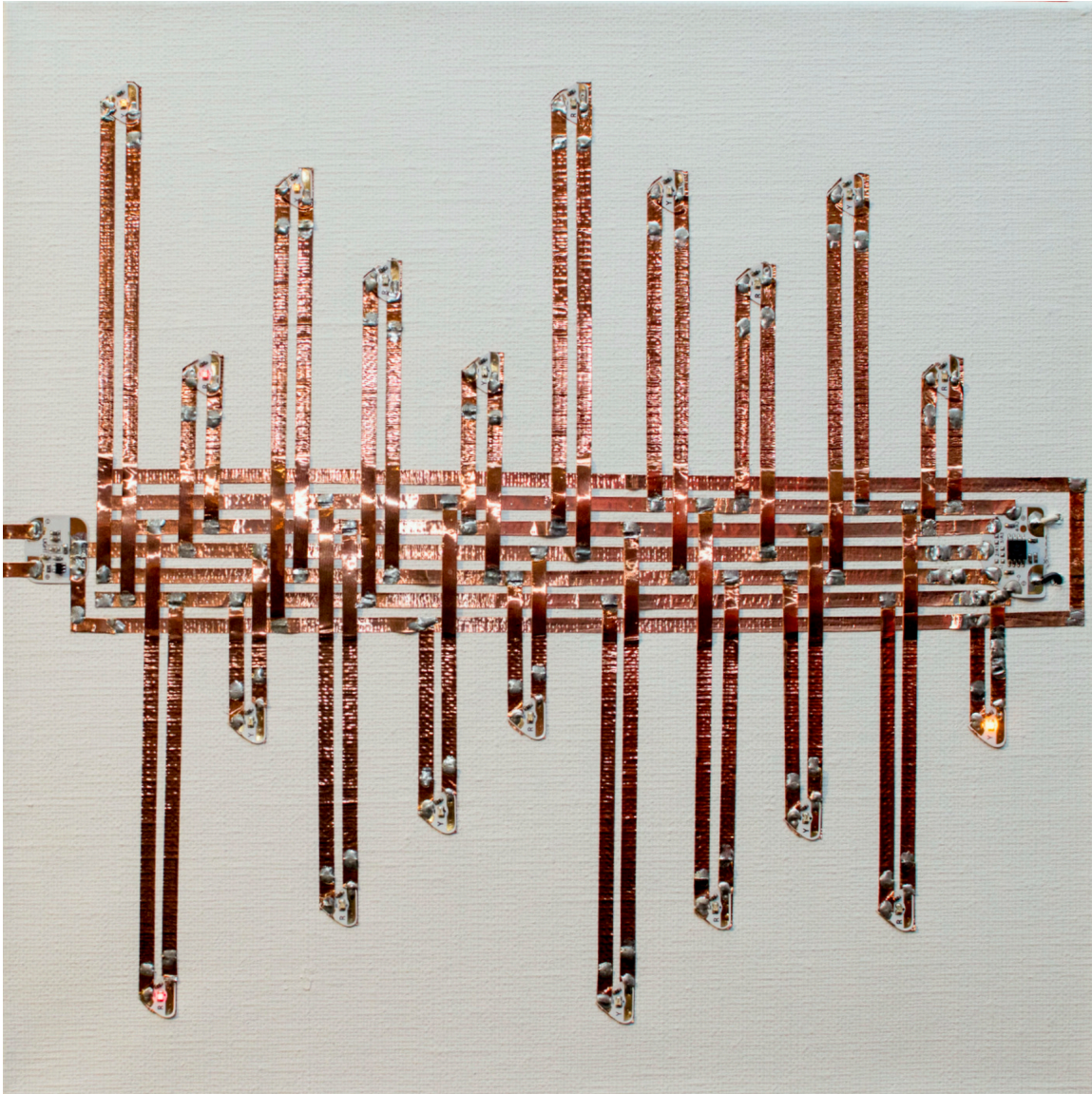

Figure A.16: *Frayed Bus* by Owen Trueblood, image by Tungshen Chew

### ***Frayed Bus***

“Inside of a microcontroller the signal from a light sensor modulates the rate at which samples are pulled from a pseudo-random number generator and fed into a Charlieplexed array of red and yellow LEDs.”

**Owen Trueblood** is a Cambridge-based hardware designer, electrical engineer and tinkerer. He designs playful circuitry, reverse-engineers consumer electronics and reprograms them to have new and whimsical interactive capabilities.

***owentrueblood.me***

## Concept

“I want to smash the crafts with the computer side of it and emphasize the computer side. Something where you look at the result on the canvas, and it has some visual aspect to it but you don’t expect anything more. Then add something that looks like magic, like it shouldn’t work or makes you ask yourself how could that be possible? I wanted something that looked handmade but there’s a powerful computer thing going on.”

*This artist began with an interest in exploring communication and leaving traces at the intersection of physical and digital spaces.*

“I thought it might be cool to have some sort of interactivity with the artwork, like cyberpunk graffiti. The 2-layered reality is something I’m really interested in, where you always have the physical stuff you can perceive with your senses and the extra limb you have nowadays—your cellphone—can perceive the other half of it.

“One concept was to have the artwork work like a QR code but look like a picture. The phone will read it as a URL so then it takes it to a website that I control. With the light sensor, if you flash the screen you can communicate to the light sensor and encode information that way. So you can transmit arbitrary data. It’s graffiti in the sense there is a static portion—the QR code is partially made out of the circuitry in a graffiti style as if it were drawn with spray paint. People can add to the artwork by drawing something on their phone and then holding up the phone and dumping it into the memory on the actual artwork. Then other people coming along can use their phone to retrieve that extra art.

“But I don’t think I will do something that uses both directions at once. It would be unfortunate if someone couldn’t participate in the full breadth of the art just because they don’t have the right cellphone. Also you have to figure it out. There is a user experience to worry about so keeping it simple is probably the best thing. I might do one directional communication though.”

*After exploring several algorithmic design approaches and iteration during construction, the concept became more about physical representations and interactions with signals.*

“The idea is an explosion of signal. When you interact, the interaction is exploded into the electronics and light pattern—the lights flash based on a pseudo-random number generation algorithm. It’s like having an explosion of the signal bus and it looks like radio waves with some interference happening. I like the aesthetic of it. It’s good enough.”

## Process

*The following process documentation is an abbreviated version of the original account from the artist's website.*<sup>73</sup>

“I started to explore what can be done with the stickers by implementing some basic microcontroller projects. One of the first designs I tried was a Charlieplexed array of white LED stickers. (*Figure A.17, top*).

“It was satisfying to use the stickers for this project because they let me lay out the actual circuit on top of the schematic that I initially drew with pen on paper. It was just a matter of putting copper tape down on top of the lines I drew for the wires, putting bits of electrical tape where they needed to cross over, and plopping LED stickers in-between. I also noticed that... over time the taped connections could fail as they relax. Jie's recommendation is to solder connections on circuits that you want to keep around for a long time so that was the solution I used when it came to the final piece.

“From the beginning I was convinced that this project would be an ideal opportunity for playing with algorithmic approaches to design. The work did not reach the final artwork directly, but at least it resulted in some interesting artifacts.

“I mostly used the wonderful Processing environment to do the prototyping. My first attempt was a very simple program that assumed the resulting artwork would be made of only vertical or horizontal copper strips, because it seemed like that would optimize the fabrication difficulty and code complexity. The program stored a grid of cells where each cell knew whether it contained a vertical or horizontal portion of tape. I calculated the size of the grid by measuring how many strips of tape could sit next to one-another on the 12" x 12" canvas that the final piece would use. (*Figure A.17, bottom*).

“After running the program the for the first time with the cells in random states I saw a complex maze-like pattern that would have to take days to fabricate by hand. To make it work I would need to tell the code to optimize for ease-of-fabrication while wrapping an interesting circuit into the pattern. Seemed like too much work so I started thinking about where I could find code that already knows how to do circuit layout. Then it hit me that CAD software for designing PCBs almost always includes automatic routing of a circuit given a layout of its parts and maybe I could just hack on that to get what I wanted.”

---

<sup>73</sup> <https://medium.com/@jmptable/playing-with-circuit-stickers-53c3ad062c38#.id283u1xk>

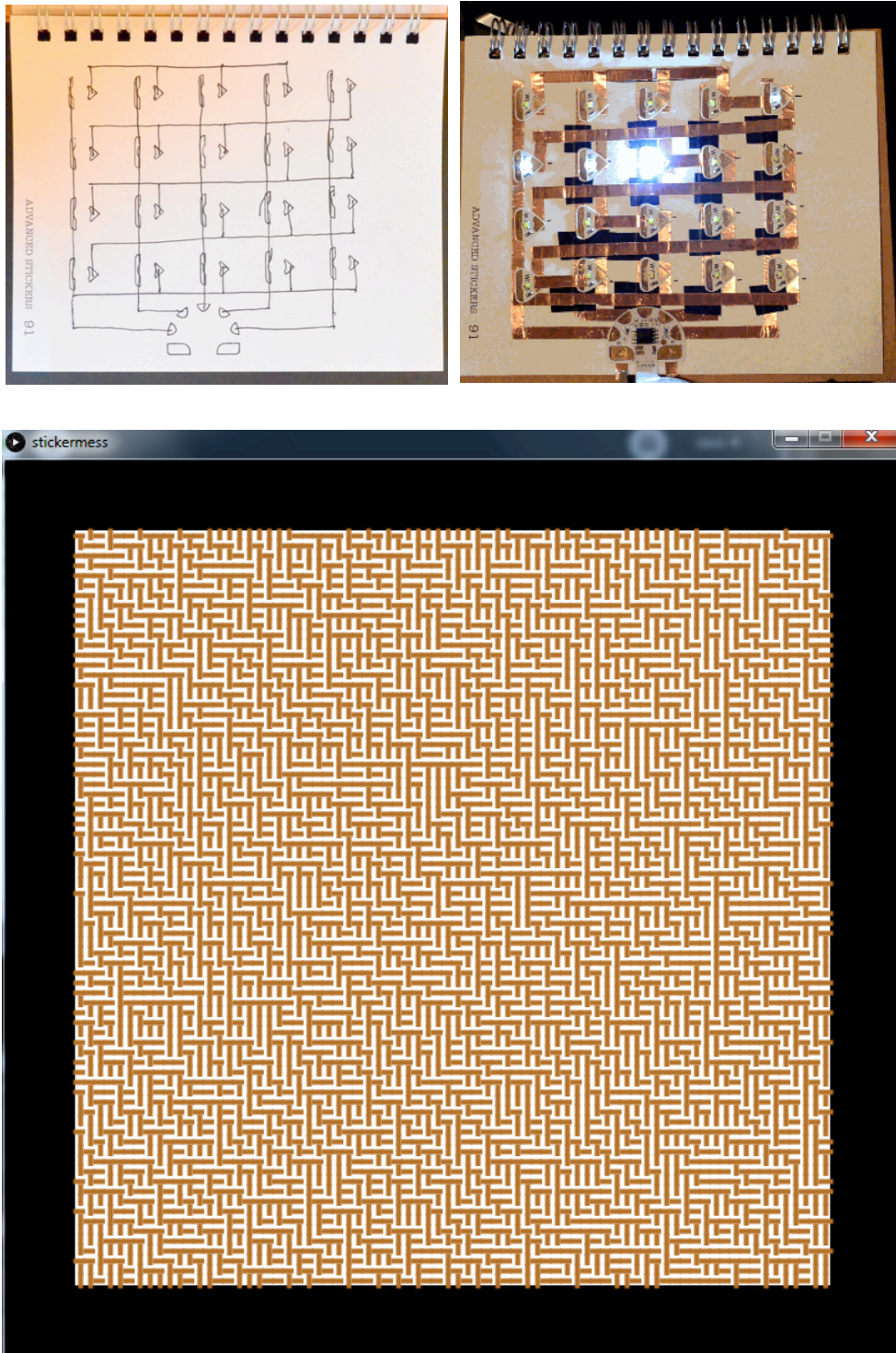

Figure A.17: Charlieplexing sketch and prototype (above) and algorithmic design experiment (below) by Owen Trueblood



## Process (continued)

“I am most familiar with Eagle (ଫ\_ଫ) so I chose it as the CAD program I would target.

As the first step I made the schematic for the 4x5 Charlieplexed LED array. Then I designed a rough footprint for the microcontroller sticker and switched to the PCB layout view. In Processing I used `java.awt.Robot` to send keypresses telling Eagle to move a random LED to a random location. Then I sent control-s to save the board file. After parsing the board file I scored the design by counting the number of times that airwires overlapped. The more overlaps there were the worse I considered the design, because every one of them would mean a piece of electrical tape to prevent short-circuiting.

*(Figure A.18, upper left).*

“It was neat to watch the computer use Eagle on its own but after spending a long time handling timing problems (losing keypresses because they were too close together) and trying to deal with other frustrating edge cases I lost steam. So I went back to Processing and worked on a slightly more manual algorithmic layout program.

“This one was still based on Charlieplexing LEDs, but it added a bus to the middle to help simplify the problem of circuit layout. I was hoping that by randomizing the distance of the LEDs from the bus I could find pleasing patterns with almost uniform distribution of the LEDs across the canvas. Unfortunately it seemed that 20 LEDs in the array (the most I could have using the 5 I/O available on the microcontroller) was just too few to make the eye see noise instead of look for geometric patterns. *(Figure A.18, upper right).*

“I made a stab at manually laying out a more pleasing circular-bus-based design in Eagle but quickly became frustrated because it was so painful to get concentric circles with the arc tool. *(Figure A.18, middle).*

“Running out of time before the final deadline I made the decision to simplify further. With some cardboard covered in painters tape as a background I played with the arrangement of the actual stickers until I found something interesting. *(Figure A.18, bottom).*

“I straightened the bus and settled on a symmetric layout of LEDs. The symmetry looked nicer than the noise-based layouts I had played with earlier and it helped make the design easier to fabricate correctly. On paper I worked out how each LED should connect to the bus based on the schematic I previously made in Eagle. Then I continued to over-complicate things.”

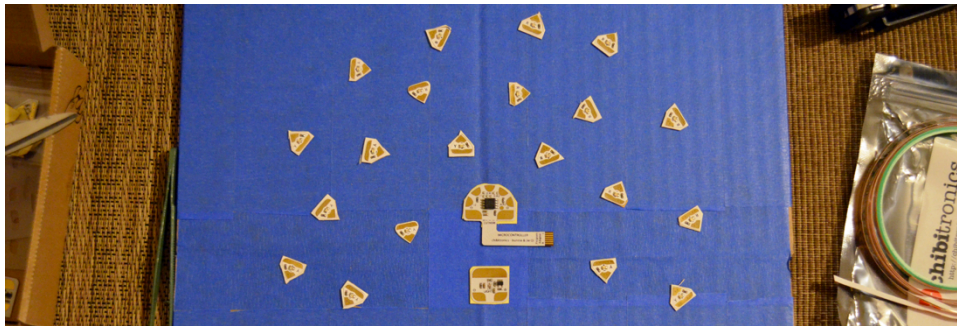
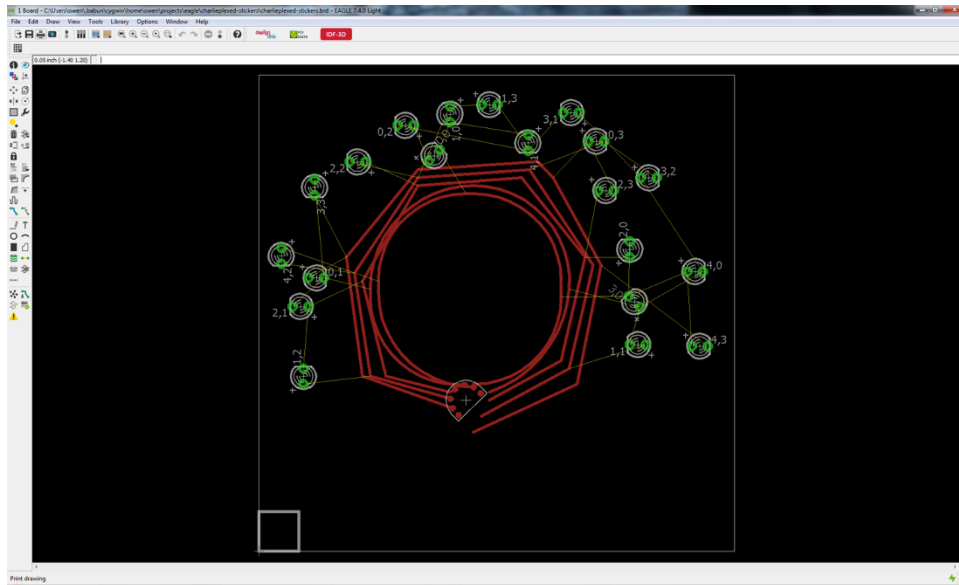
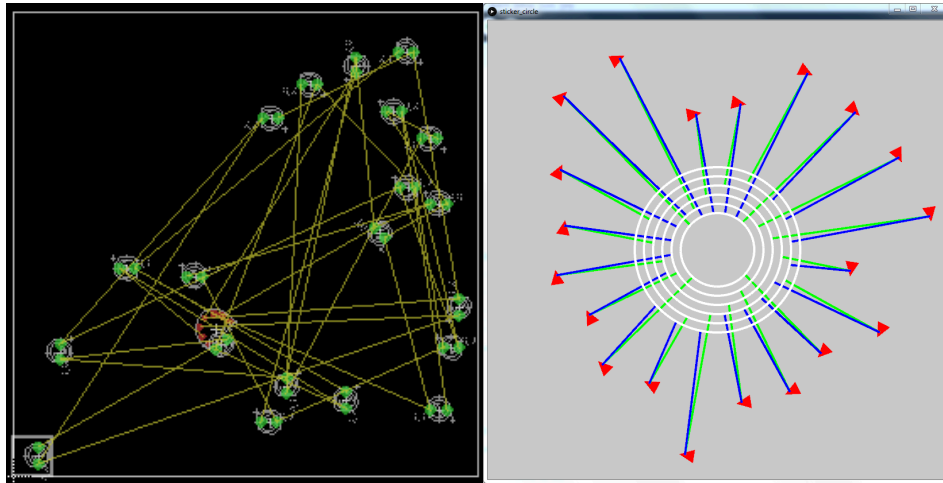

Figure A.18: Algorithmic circuit layout experiment (top), manual routing (middle) and physical prototype (bottom) by Owen Trueblood



## *Process (continued)*

“Intimidated by the immaculate 12x12 white canvas I intended to use as the artwork’s final substrate I set out to make a one-to-one draft of my design before transferring it in final form onto the canvas. I grabbed an unused desk drawer, an old laptop, a utility knife, markers, and a roll of painter’s tape. (*Figure A.19, bottom left*).

“Using the back of the laptop as a cutting surface I laid out painters tape and cut it into strips roughly the width of the copper tape that Jie gave me. I did not want to use the actual copper tape for the draft because I doubted I could peel it off cleanly, my supply was not very large, and it is pretty expensive stuff. It took an hour of painstaking work with the knife but at the end I had a good stand-in for the copper.

“I put down the 5 lines of the bus, an outline of the microcontroller sticker, and an outline of the light sensor sticker. Then I measured a one-inch grid and marked it on the surface of the drawer. Laying LED stickers on the grid I tried out many different arrangements. Noisy designs didn’t work because the straight lines of the grid force the eye to try to find patterns. Lots of obvious symmetric designs looked silly by being too simplistic, like profiles of sine, sawtooth, or triangle waves. I tried to chop up the profile and as a result got a sort of interlaced pine tree.

“After getting comfortable with the draft of the design I set out to transfer it over to the canvas. In the recent past I have played with projection mapping, so every problem must be solved with projection mapping. I built a rig over the table to hold a laser pico projector in place. Then I hooked it up to my tablet and opened a drawing app. I traced the key points of the design in light and then removed the drawer. (*Figure A.19, top*).

“Once I had the canvas at the right location, orientation, and height I started tracing under the light with copper and circuit stickers. The process was not completely smooth because the canvas was easily nudged out of alignment with the projector, but the basic principle was sound.” (*Figure A.19, middle*).

“Final changes included adding the light sensor on the side opposite the microcontroller, trimming the tape for neatness, soldering the tape connections to make them permanent, and, of course, writing the firmware to make it actually do something.

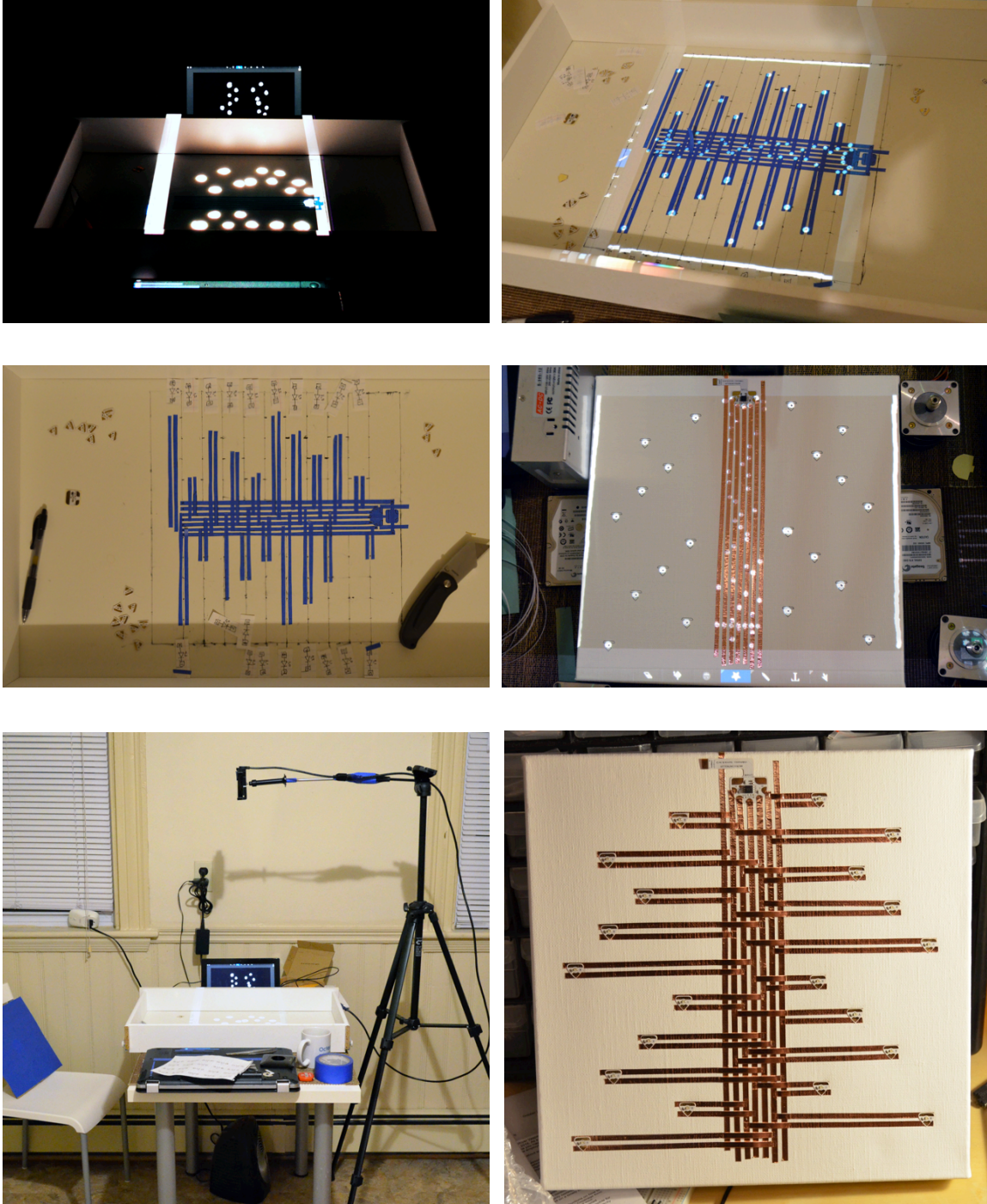

Figure A.19: Projected design traced with painter's tape (top), translating painter's tape to copper tape circuit (middle), projector setup (lower left) and final *Frayed Bus* circuit (lower right) by Owen Trueblood

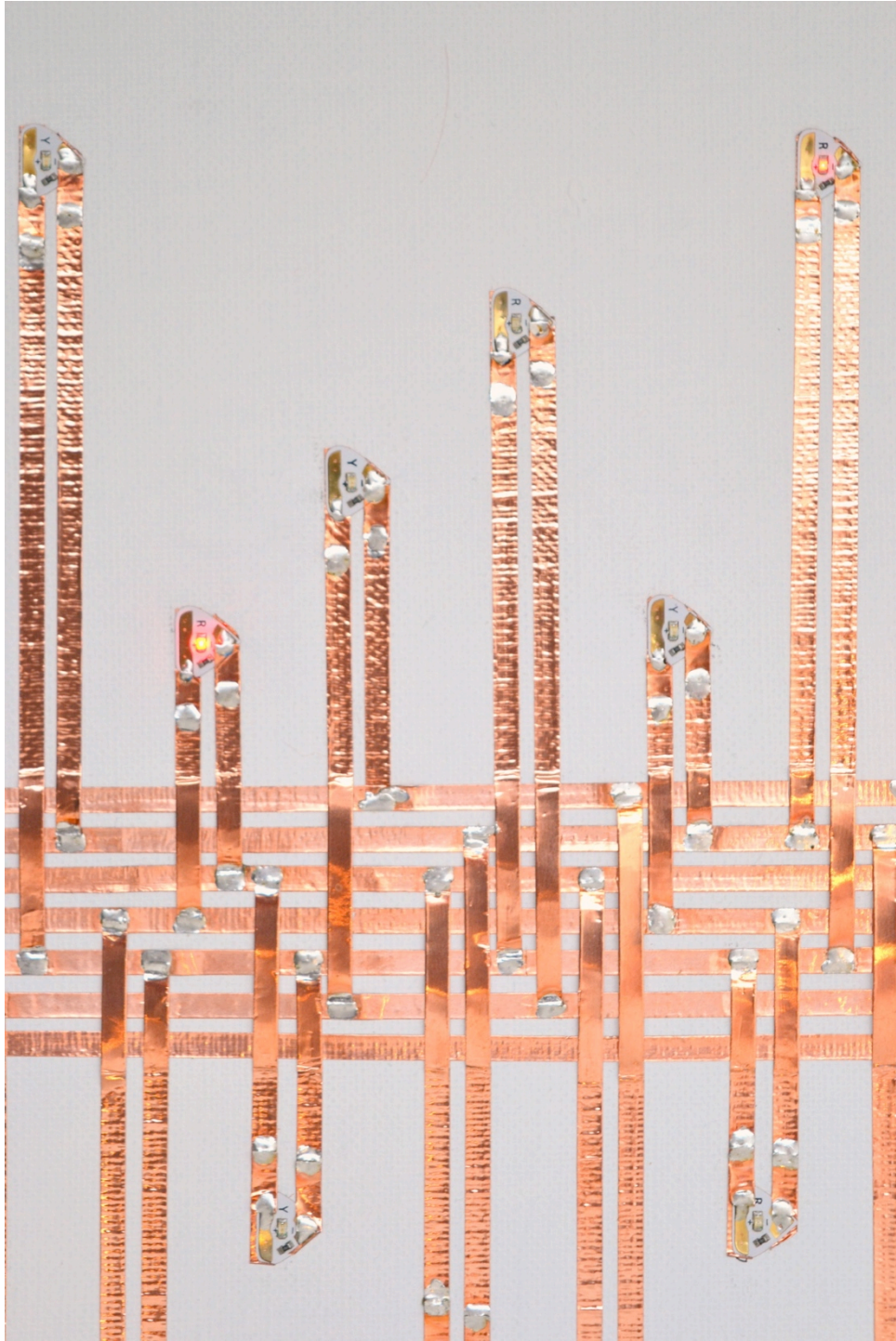

Figure A.20: Detail of *Frayed Bus* by Owen Trueblood



## *Outcomes & Insights*

“Normally I design a thing and I send off the design and someone else makes the thing. I tried really hard to keep that design centric approach where you put all the effort into the design and the fabrication is a small part of the process. But here the fabrication was a very large part. This specific layout was simple, so the design there was pretty small relative to the time it took to make.

“This was the first time I tried to apply algorithmic design to a physical thing that is not produced by a robot. I’ve definitely done projects where I built a robot, then do the design algorithmically and then the robot makes that a reality. It was a little too much. I’m slow, very slow. Robot is also slow, but more patient than I am. Maybe you could make a robot to lay out circuits in tape like this but that takes away what I think is the point of these. Like it’s supposed to be done by hand—hands on.

“I liked making this stuff with my hands. I really liked making this but it was a painful process—because it was painstaking. But when I was playing with them before, I was just making random stuff. I didn’t really care it works or that it looks exactly right. For that it’s really good and satisfying to see when you fold a piece of paper everything lights up. It’s very direct.

“I’ve never put anything on a canvas or in a presentable form like this. Whenever I was thinking about the design, I could have used something that didn’t look visually nice in order to get the array that I wanted but I always thought I would have to put some piece of tissue paper or something on top. And I didn’t want to obstruct it. I wanted the circuit to be part of the piece.

“Normally I can fix a problem by adding, but this time to do anything took a long time because I didn’t want to make marks on the canvas. If I were to do this again, I definitely would have bought a lot of sticker stuff and just iterated physically. I was too unwilling to do physical prototypes.

“Coming up with some grand vision and the result is some completely different vision—that’s very me. That’s reflected in the spastic—how this thing acts is very disheveled and the design the process was very disheveled—I was stealing scraps of time working on it for an hour or two. It kind of feels right that it randomly blinks and is abstract visually.”



Figure A.21: *Quiet Invitation* by Mary Uthappuru

### ***Quiet Invitation***

“After the sun goes down and night takes over, fireflies flash back and forth to find a mate in the dark space. On a decomposing log, foxfire glows and entices insects to crawl on its caps so its spores can travel on its visitors’ legs. Through the use of conductive materials and handmade paper, *Quiet Invitation* simulates the way two organisms utilize bioluminescence as a request to aid in survival by taking advantage of another organism’s undeniable attraction to light.”

**Mary Uthappuru** is a book artist, book binder and book conservator from Indiana. Her creations are inspired by nature, literature and travel.

***springleafpress.com***

## Concept

“When I sat down to really think about what I would do for this, immediately bioluminescence came to mind. It is always on my mind, really. Who can resist the glimmer or flash of light emitted from a plant, animal, bug, or bacteria? It is something that borders on super powers. There is something that pulls us towards an unexpected light source drawing our curiosity in to find out more.

“My interest in bioluminescence and how that could be represented by LED lights was clearly what I wanted to pursue. Of the many creatures that utilize this light emitting chemical reaction, I needed to choose one or two to focus on. The way I was able to do so was to ask why these organisms do it in the first place.

“A fish, like the angler, will use light as a lure in the darkness of the ocean to attract its meal. Small shrimp emit a cloud of light so they can escape predators. I have a huge fascination with the ocean, but I couldn’t manifest a mental image of my project. So I went to land and finally came to fireflies (a common beetle) and foxfire (a fungus). The firefly flashes to attract a mate. Foxfire glows like a lantern in the middle of a dark forest to attract bugs that will crawl all over it and then walk away carrying its spores as they walk away. This idea of light as an invitation for an interaction fits perfectly with the way I think humans are attracted to lights ourselves.

“So there was nothing left to do next but to start making some fungus, something I hope to be known for saying in the future.”<sup>74</sup>

---

<sup>74</sup> <https://www.springleafpress.com/quiet-invitation/>

## Process

*The following process documentation is an abbreviated version of the original account from the artist's website.<sup>75</sup> The artist has also shared the code for the piece on Github.<sup>76</sup>*

“To create the foxfire mushrooms, I went to the handmade paper I have acquired from Andrea Peterson of Hook Pottery Paper. Needing the ability to mold the paper without the risk of tearing it in the process was very important, but because I wanted them to glow, the paper I used had to have some transparency as well. A few of the pieces were lightly painted with brown drawing fluid, before wetting, to simulate natural color variations. The paper was saturated with a spray bottle, then scrunched on the table to create the mushroom gills. The pieces were clipped at the base and were left to air dry. With a water pen, I was then able to apply water to the areas that I wanted to further sculpt. (*Figure A.22, upper left*).

“Next, was to figure out the arrangement of the foxfire as they would appear to grow on a log in nature. It was hard to think in the round, and I felt like it would be beneficial to have the foxfire built up on strips of paper rather than directly on the log. So I created a curved substructure from cardboard then used lots of masking tape to keep each strip in place. (*Figure A.22, upper right*). I didn't worry about where the lights would go at this point. It would be easier to figure out their placement once the mushrooms were arranged on the log. As I added the mushrooms, I realized my cardboard wasn't holding the shape enough to attach each piece, so I shoved colored pencils in there to fit the contour and they made a perfect stabilizing aid. The pencils served a second purpose as I needed to arrange the separate clump of mushrooms that would be placed further down the log. (*Figure A.22, middle row*).

“As I was making the foxfire, it occurred to me that the bottom of the piece would not only look bare, but the log would appear to float without something to give it context. Staying true to the facts of foxfire, it grows on logs, but specifically on those that are on the forest floor, because of the moisture. So leaves were made from more handmade paper by first cutting out their shapes, then applying a few thin layers of drawing fluid until I achieved the color I was looking for, and finally allowing them to air dry for maximum 'dry leaf curl.' Stems were made with painted threads glued on. (*Figure A.22, bottom*).

---

<sup>75</sup> <https://www.springleafpress.com/quiet-invitation/>

<sup>76</sup> <https://github.com/springleafpress/foxfire/blob/master/foxfire.ino>



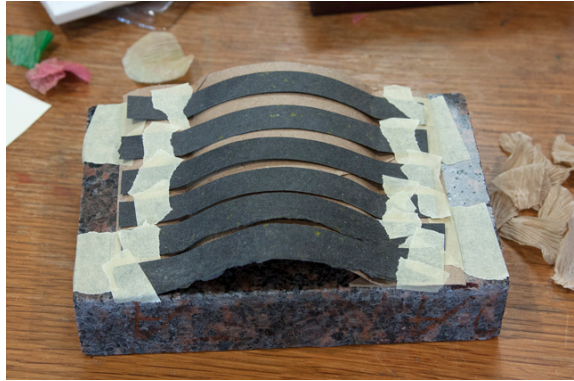

Figure A.22: Sculpting mushrooms and leaves with paper by Mary Uthupuru

*Process (continued)*

“The log was then made with a heavy cotton and straw handmade paper that was sprayed with water, then wrapped around a log I had in the backyard. Once dry, it held its shape perfectly! The strips of paper that had the mushrooms on them were glued in place. (Figure A.23, upper left).

“With that done, it was time to consider the LEDs and their placement. I was looking to achieve the effect of glowing mushrooms, so my initial thought was to put the lights behind the paper so they would be hidden, and let them illuminate from below. I punched holes where I thought they were needed, but after testing lights in a few spots, there was not enough light to do what I wanted. So I switched to a different type of LED that could be hidden among the mushrooms.

“The type of light I used requires conductive thread or wire as opposed to the copper tape that I was given. I used thread to create the circuitry, which was tied from light to light, each thread traveling on the “back” of the log, until they were all connected. The action that these lights were to perform was to fade on all at once, for a period of time, then fade off together. This meant that they could all be on the same parallel circuit. Because of the windy path the thread travels, there was the risk of the threads shifting and touching one another, which would cause a short circuit. Once the threads were where I needed them, I used pieces of glued paper to fix them in place. (Figure A.23, upper right).

“Next to consider was the circuitry for the rest of the piece. The fireflies would be the next major part, but I had also decided on another aspect of the narrative I was setting out. Having the foxfire glow and the fireflies flash didn’t give much information other than those things light up. The actions needed context. As I was forming the previous components, it occurred to me that what was needed was just an indication of time. These things only perform after dark. So the passage of time could be conveyed to the viewer by two more circuits of lights: daylight and sunset.

“The remainder of the circuitry for this piece would be done with the Chibi sticker LEDs and copper tape. In order to ensure that the connections between the lights and the tape wouldn’t fail over time, it was suggested that they be soldered in place. I don’t have reason to solder often, so I wanted to do a test to be sure I knew what I was doing. Plus, soldering is ridiculously fun.



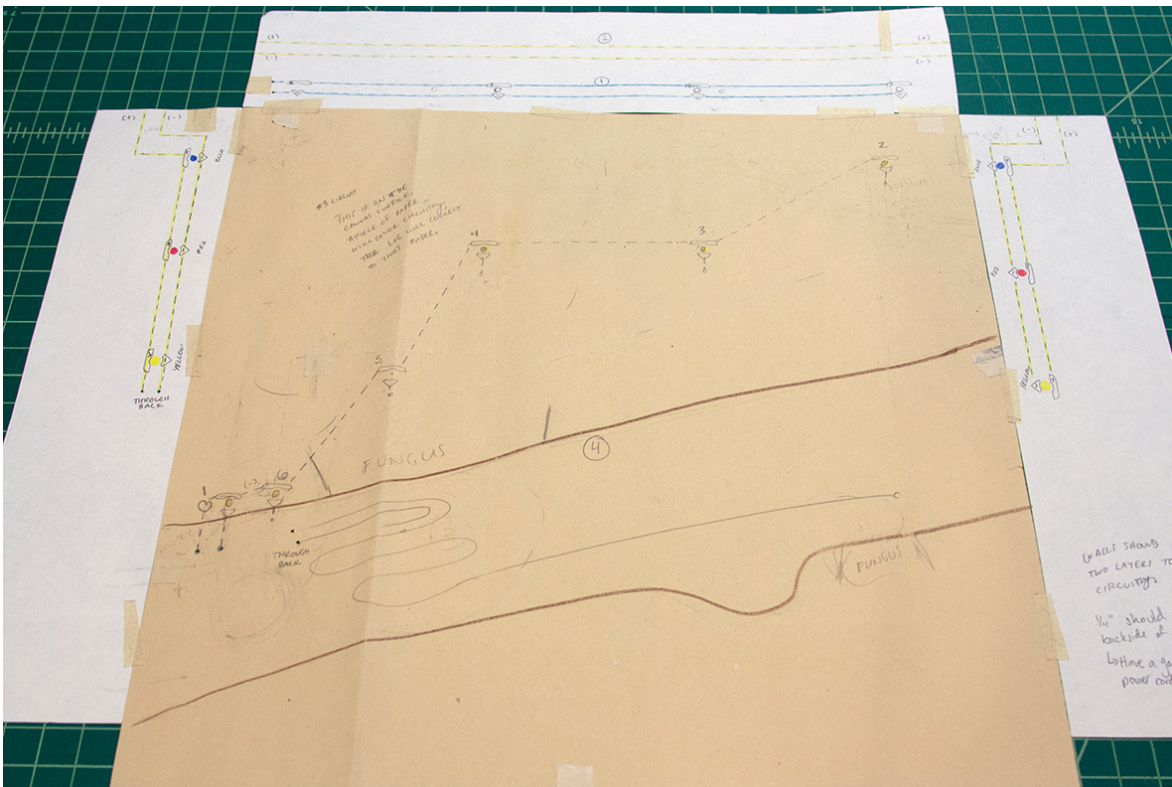

Figure A.23: Making circuit with conductive thread on paper log (top) and sketch for circuitry layout (bottom) by Mary Uthappuru

### *Process (continued)*

“To begin, the firefly lights (yellow) were put in place. The fireflies would be made to look like they were communicating with one another, flashing back and forth, which would take six lights. Since each of these lights would produce its own action, they each had to be on their own circuit. (*Figure A.24, top row*).

“The negative nodes of the lights could be connected to one another, but each of the positive charges had to travel to a separate pin on the microcontroller. To be efficient with my circuitry, each positive connection traveled to the back of the canvas through a hole. They could be connected with the rest of the circuits at a later point. The log was then used to figure out where its circuit would pierce the canvas but not attached yet. (*Figure A.24, second row*).

“At this point, I wanted to be sure all of the things I had planned for the piece would function. As I was getting help with the coding aspect of the project, I needed to give time for that as well. [Figure A.24, third row, left] includes an Arduino Uno microcontroller, mounted on the left, and a breadboard, mounted on the right. I would use a microcontroller just like the one in the photo, but the breadboard just helps us create the circuits that would be used in the piece without having to have the actual piece ready. The code was written and it could do everything I wanted!

“I mentioned the need of a frame for the daylight and sunset lights. This frame was made from binder’s board covered in white handmade paper that I had painted to simulate light blue skies. Another piece of paper was painted the same way to cover the canvas. (*Figure A.24, third row, right*).

[A.24, bottom] shows double-sided tape around the circuitry so that the paper would sit directly on top of the lights. I tried gluing the paper in place first, but it warped in a way that was much too distracting. The background paper was secured to the tape, and the edges were wrapped and glued to the back of the canvas. In bookbinding, this is referred to as ‘drumming’.



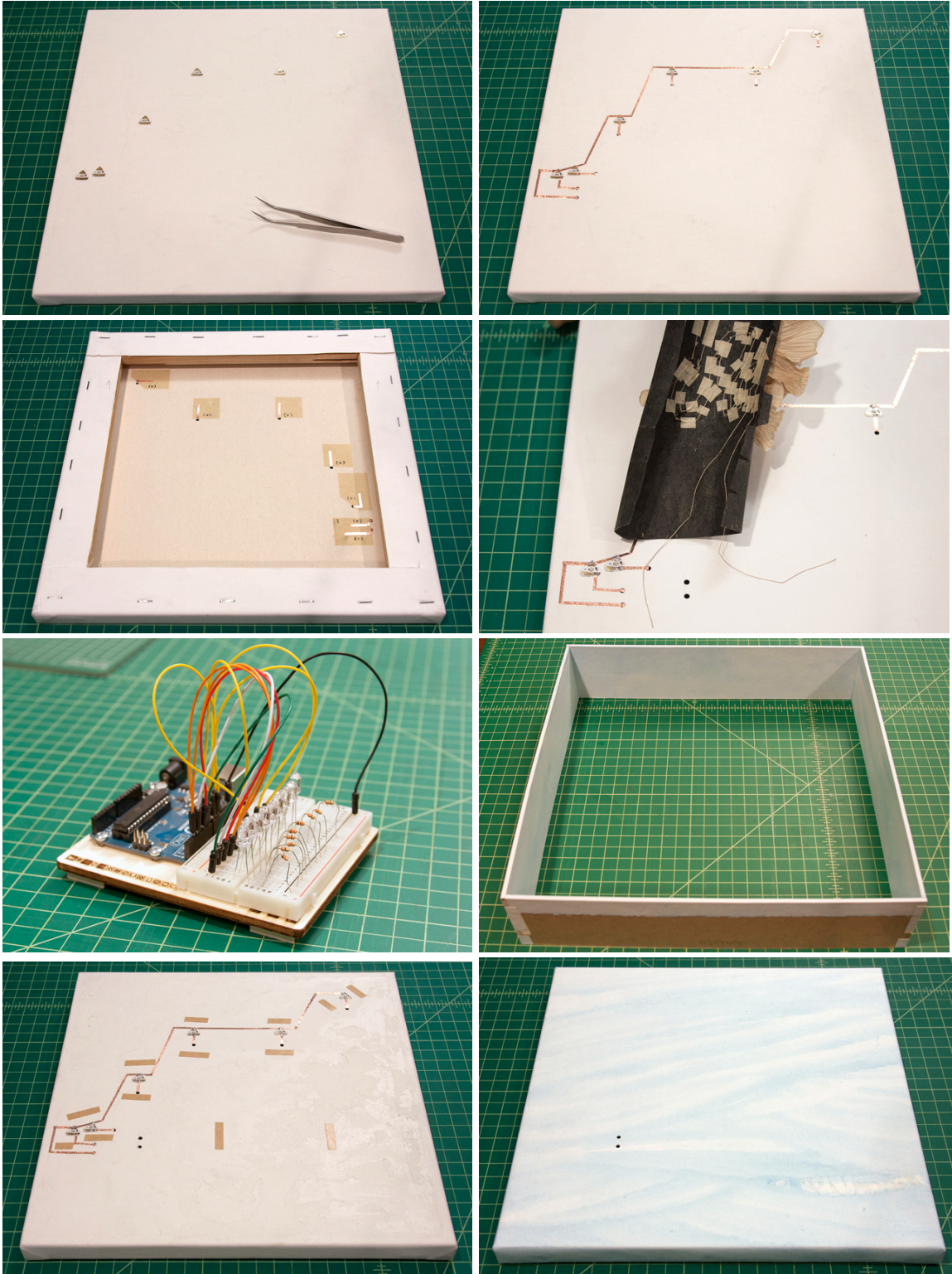

Figure A.24: Assembling firefly circuitry on canvas (top and second row), test circuit with Arduino (third row, left) and frame (third row, right) and wrapping the final background circuit in paper (bottom row) by Mary Uthupuru

### *Process (continued)*

“The log was then attached and the conductive threads were fed through to the back. The lights that would create the effect of daylight giving way to sunset would be mounted to the board frame. (*Figure A.25, top row*).

“In order to cast their light effectively on the piece instead of just across it, I mounted them to small wedges I made from thick folder stock. This is a view of the frame with the lights in place along with their copper tape circuits. The circuits would travel to the outside of the frame to connect to the rest of the circuits on the back of the canvas. All connections were soldered once fixed. (*Figure A.25, middle row*).

“[Figure 27] shows the frame connected to the canvas and the circuits wrapped in place. The yellow paper that is under the copper tape was glued there first provide a smooth surface for the copper tape to stick to reliably.

“With all the circuits now in place on the back of the canvas, I just had to figure out how to connect them all to the microcontroller. The circuits were made with two different types of conductive materials, neither of which could make a connection to the Arduino Uno. So I would have to use wire to connect everything to the brain.

“Wires were soldered to each line. Then, the wires were shaped, as neatly as possible, to get to the Arduino. At this point, the Arduino was not connected to the canvas because I wanted room to work on securing the wires. I glued down the wires with paper and labelled each one’s pin location as it would correspond with the microcontroller. The Arduino was glued in place and the wires connected. (*Figure A.25, bottom row*).

“Everything was tested a final time. A wooden frame was built around the piece to hide and protect the exterior circuits which would also help hide the lights on the front of the piece.”





Figure A.25: From left to right, top to bottom: Assembled log circuit, frame LEDs, frame with assembled LEDs, circuitry wrapping around edge of canvas, circuitry controlled by Arduino and final circuitry assembly for *Quiet Invitation* by Mary Uthuppuru



Figure A.26: Details of *Quiet Invitation* by Mary Uthappuru

## *Outcomes & Insights*

“My process is more scientific than artistic. I start with an idea—it’s big and unwieldy—then I read a lot, make lots of drawings to figure out how something will work and make some models. I’ll talk to someone who knows the content of what I’m working with. It’s like echolocation: finding out your idea by talking to other people, bouncing it off people. Then that helps define and hone in on the work.

“Right now I always start with paper, board and cloth (these are what books are made of) as bones but then add paint or dye or use other elements to make it what it needs to be. It helps that there are only so many materials I start with and then I can make those materials do whatever I want. I feel like more materials muddy the waters. If there are always so many possibilities, it’s hard to focus.

“But even paper itself is not a solid thing. My friend who is a hand paper maker introduced me to the idea that it’s not just one type of material. It can be molded, cast or you can even embed things in the paper. I also sew a lot through paper. By now I know the properties of paper pretty well and don’t need to work too hard to force it into that [desired] form. The better acquainted I am with a material, the more likely I am to include it in my work.

“What’s different about these [circuit] materials is that they have action, whereas most materials that I use are inert—they don’t do anything. You have to do something extreme to make them active. This makes it more detailed in terms of what I need to consider—I need to think longer. But physically making it will be my usual process: test, retest, make a model, put on the piece and go through it all over again.

“The techniques I used were fiddled along the way. I created a new technique for every new visual effect. I sculpted paper in new ways and this was the first time I soldered on paper! I have a purpose and I figure out whatever has to happen to make it a reality. But if I do it again, I might choose a different method. This time I used too many different types of conductive materials and had to figure out how to secure from one material to the next. Luckily someone else online had tried—I looked through blogs and forums.

“My book background makes me want to tell a story—lead viewers through a narrative like turning a page. I wanted to add a glowing button—light on the button attracts humans just like insects—but ran out of time. Even so, the time-based aspect [of electronics] allowed me to tell my story. I used time and animation-based storytelling rather than page-turn and motion based. The passage of time was a theme.”



## **PAPER CURIOSITIES: EXTENDED EXHIBITION**

Following the original six artist case studies, I opened a broader call for participation to contribute to the *Paper Curiosities* exhibition. The following section shares images of these artists' final pieces and their written explanations for each piece (Figures A.26 to A.30).

Additional resources such as video are available at **[papercuriosities.media.mit.edu](http://papercuriosities.media.mit.edu)**.



**Blue by Ema Kaminsky**

“Many fish species have the ability to glow in the dark, revealing beautiful neon colors. Through a light sensor and colorful LED lights, the art piece aims to mimic fluorescence phenomenon of certain fish species in deep blue ocean. Find the fish that controls the glow of other fish by making a shadow.”



**Galaxsea by Katherine Hashimoto**

“This octopus has caught something special in his bottle. He loves the dark and may blush if you cover his eyes.”



**Octopus by Christina Sun, Kiran Wattamwar**



**Untitled 85 by Asli Demir**

“The piece explores how light finds a place and fits into different forms.”

**Figure A.27: Artworks featuring illuminated nature**





**Trox Circuit Study 05 – IcosaTrox  
by Jonathan Bobrow**

“This study explores how geometric forms found in nature and modularity or press fit objects can compose stable structural and electronic systems. Electricity is passed through copper contacts that are placed in tension and compression to result in balance, much like an electric Tensegrity.”

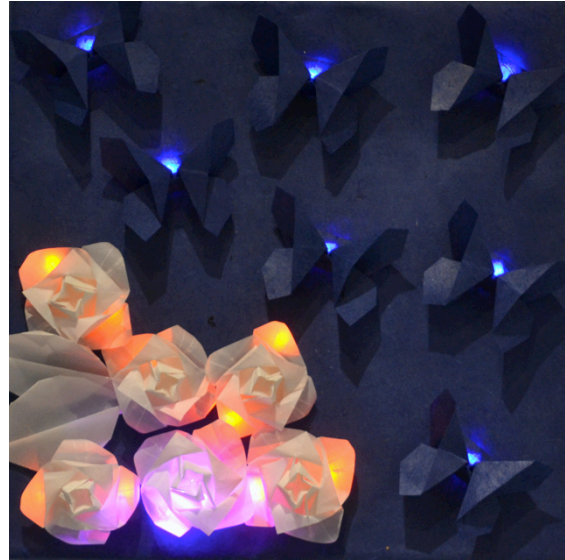

**Flower Fluorescence by Alisa Ono**

“I decided to combine origami, traditional Japanese paper art, with the new, an LED circuit! I wanted movement and contrast in my piece, so I used an effect sticker to make the butterflies flicker in contrast to the unwavering roses. Butterflies are the same color as the background, so they could be easily overlooked, but the LEDs bring life into them.”



**Illuminating the World by Ayesha Dawood**

“Circuit Sketch Art and the power of imagination and digitization. Creating a Connected world. Connectivity matters. Communication matters.”

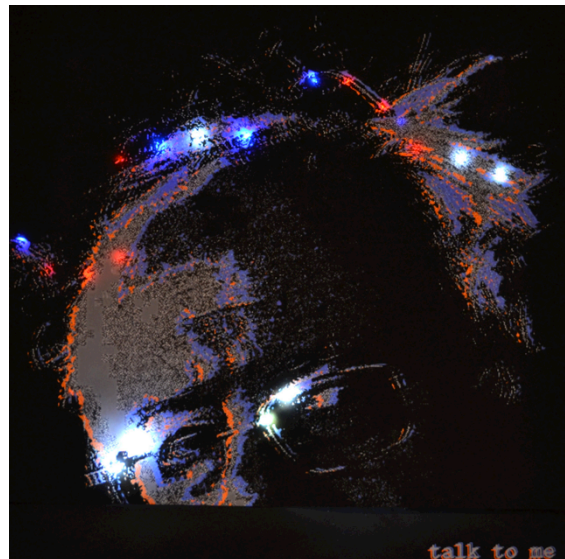

**Bernie by Joy Yang**

“I hope this piece captures some of the bizarre, anxious energy from this election season. Light is a great symbol for hope, excitement, technology, and uphill struggles late into the night. Shout at Bernie. I’d recommend ‘feel the Bern’ but please choose your words according to how you feel about him.”

**Figure A.28: Pieces exploring origami (above) and civic themes (below).**



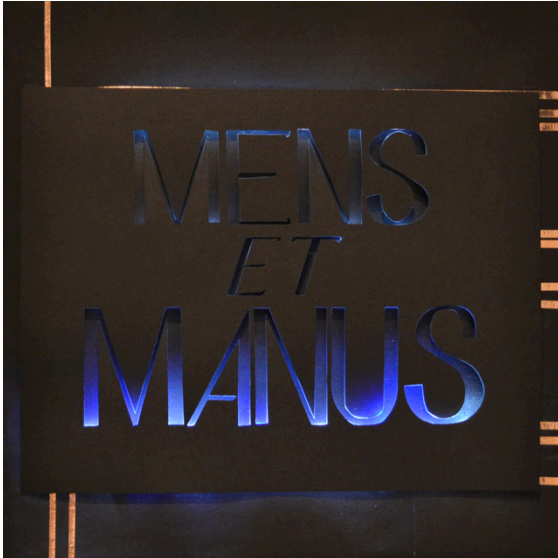

**Pulse by Stacy Mo**

“Mind & Hand: a concept so easily hidden by exams, problem sets, and the slew of other commitments each student has but illuminated by the things that make the institute unique: hacks, innovation, and bravery to explore.”

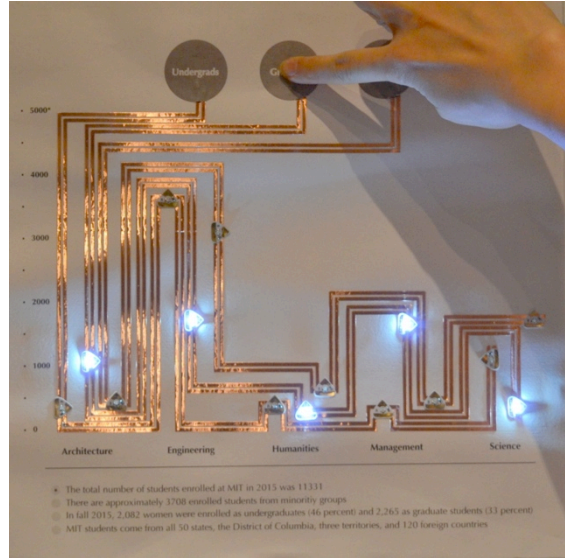

**MIT Enrollment Information 2015**

**By Ani Liu, Jasmin Rubinovitz, Penny Web**

“At the start of their sophomore year, MIT students select an academic department to major in. This visualization shows the distribution of students enrolled to each school at MIT, divided by their level of studies. Click the circles on top to see the enrollment information for each degree group.”

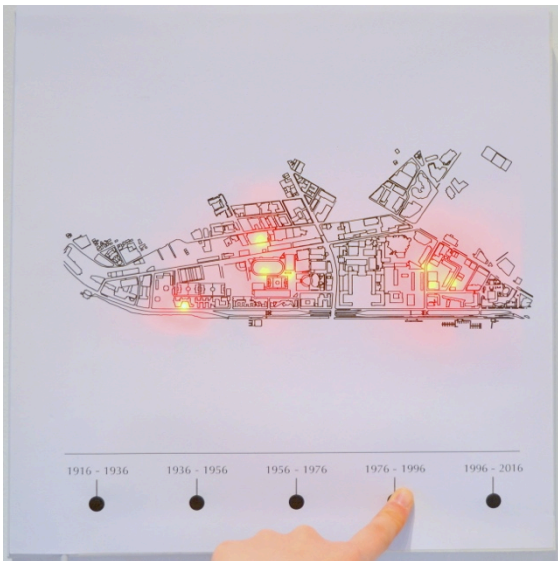

**MIT Campus Development Through Time**  
**By Ani Liu, Jasmin Rubinovitz, Penny Web**

“Since crossing the Charles river from Boston to Cambridge in 1916, MIT campus has kept growing and spreading, adding new spaces for innovation every year.”

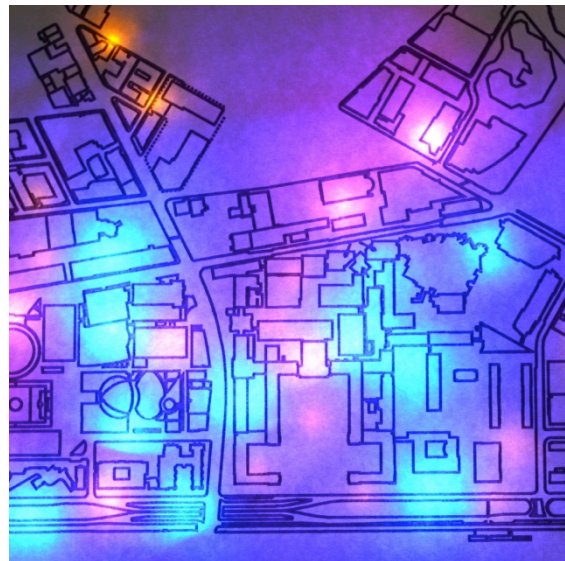

**MIT Campus Development Through Time – Detail**

“This map shows the buildings that were added throughout MIT’s 100 years in Cambridge. Click the markers at the bottom of the image to see the buildings built during those years”

**Figure A.29: Artworks about MIT**

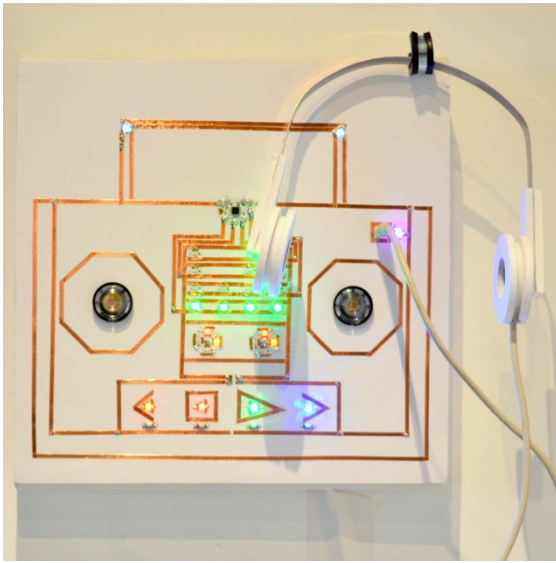

**Boom in a (Paper) Box by Anthony Landek**

“This is an ode to the rich history of the beautiful old school boom box. Boxes full of intricate circuits, coated with a plethora of knobs and switches, and a plentiful amount of pulsating lights. The boom box. The antithesis to the iPod. The nightmare to the downstairs neighbor. The portable generator of music memories. The boom box. It took the music from the hands of the radio DJ and put it in the hands of the masses. Took the music from the living room record player to the streets, beach, basketball court, and BBQ. Let the boom box live on!

Instructions: The four buttons at the bottom of the canvas each trigger a different song. Hold down a button until a song starts and then release. Press and hold the same button to stop. Repeat for all four buttons.”



**Reflections by Rahul and Emily Bhargava**

“Both foiled stained glass and circuitry depend on the unique properties of copper, one to allow glass to be connected to glass in versatile ways and one to carry an electrical signal. The current use of copper tape as circuitry reflects the more traditional uses of copper foil as a craft material.”

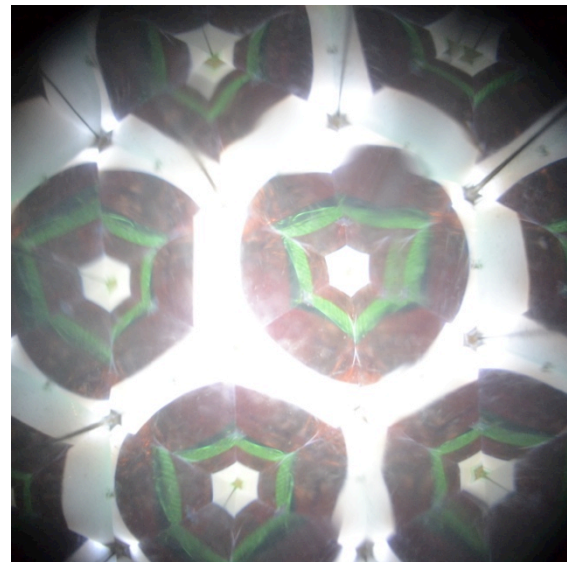

**View through kaleidoscope**

“In this piece glass alone creates a kaleidoscopic image, but with the introduction of LEDs the image takes a modern twist. The physical kaleidoscope provides further ancient and modern complexity, using traditional mirrors to create an infinite set of reflections of the stained glass’s shapes, and using a light sensor to add further color to the image. Reflection upon reflection.”

**Figure A.30: Artworks featuring interactive devices: paper headphones to explore music with paper themes (top) and kaleidoscope to play with reactive and reflected lights (bottom)**

# Appendix B: Modular Programming

## MODULAR PROGRAMMING CONCEPT TOOLKIT

Inspired by the idea of creating a “modular synthesizer style programming kit,” I designed a set of sticker primitive concepts that enable computational behaviors coded by traditional Arduino<sup>77</sup> programming without the need for a screen-based programming environment. Instead, behaviors are programmed through tangible user input, adjusting sticker settings through physical dials on the sticker and creating electrical connections between sticker inputs and outputs. The stickers are divided into signal generators, signal filters and logic.

I created versions of the *Play* and *Compare* module, along with a potentiometer and light sensor module, for a pilot kit. This is described in the *Code Collage: programming with circuit stickers* section of *Chapter 7: Paper Programming*.

The following table lists the basic components and their functionalities:

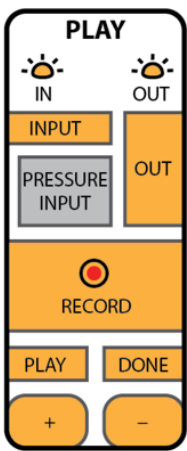
Signal Generators	
	<ul style="list-style-type: none"><li>- Takes analog input voltage from <b>INPUT pin</b> or on-sticker pressure sensor</li><li>- Records voltage pattern for up to 30 seconds</li><li>- Outputs recorded voltage pattern when <b>PLAY pin</b> activated by HIGH signal</li><li>- When playback completed, <b>DONE pin</b> outputs momentary HIGH</li><li>- For repeating looped playback, connect <b>DONE pin</b> to <b>PLAY pin</b></li></ul>

<sup>77</sup> Arduino. <https://www.arduino.cc/> (2016).

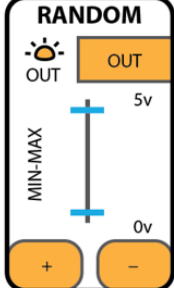
 <p>The diagram shows a 'RANDOM' module sticker. At the top, it says 'RANDOM'. Below that, there are two sun-like icons representing LEDs, labeled 'OUT' and 'OUT'. Under the first 'OUT' is an orange box labeled 'OUT'. In the center, there is a vertical slider labeled 'MIN-MAX' with a blue bar. The top of the slider is marked '5v' and the bottom is marked '0v'. At the bottom, there are two orange buttons labeled '+' and '-'.</p>	<ul style="list-style-type: none"> <li>- Outputs random voltage from 0V to 5V</li> <li>- User sets minimum and maximum voltage using on-sticker sliders</li> </ul>
--	--

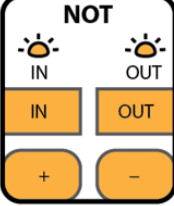
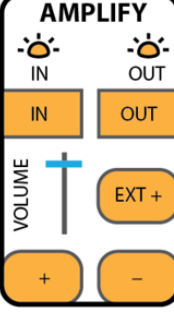
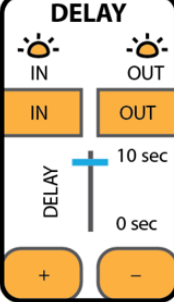
Signal Filters	
 <p>The diagram shows a 'NOT' module sticker. At the top, it says 'NOT'. Below that, there are two sun-like icons representing LEDs, labeled 'IN' and 'OUT'. Under the 'IN' icon is an orange box labeled 'IN', and under the 'OUT' icon is an orange box labeled 'OUT'. At the bottom, there are two orange buttons labeled '+' and '-'.</p>	<ul style="list-style-type: none"> <li>- Takes analog input voltage 0V to 5V</li> <li>- Outputs opposite voltage, mapping from 5V to 0V</li> </ul>
 <p>The diagram shows an 'AMPLIFY' module sticker. At the top, it says 'AMPLIFY'. Below that, there are two sun-like icons representing LEDs, labeled 'IN' and 'OUT'. Under the 'IN' icon is an orange box labeled 'IN', and under the 'OUT' icon is an orange box labeled 'OUT'. In the center, there is a vertical slider labeled 'VOLUME' with a blue bar. To the right of the slider is an orange button labeled 'EXT +'. At the bottom, there are two orange buttons labeled '+' and '-'.</p>	<ul style="list-style-type: none"> <li>- Takes analog input voltage 0V to 5V</li> <li>- Outputs voltage scaled to 0V to 5V</li> <li>- If <b>EXT + pin</b> is connected, scales to external power supply</li> <li>- User tunes “volume” (degree of amplification) with on-sticker slider</li> </ul>
 <p>The diagram shows a 'DELAY' module sticker. At the top, it says 'DELAY'. Below that, there are two sun-like icons representing LEDs, labeled 'IN' and 'OUT'. Under the 'IN' icon is an orange box labeled 'IN', and under the 'OUT' icon is an orange box labeled 'OUT'. In the center, there is a vertical slider labeled 'DELAY' with a blue bar. The top of the slider is marked '10 sec' and the bottom is marked '0 sec'. At the bottom, there are two orange buttons labeled '+' and '-'.</p>	<ul style="list-style-type: none"> <li>- Takes analog input voltage pattern</li> <li>- Outputs exact voltage pattern after initial delay</li> <li>- User sets initial delay time with on-sticker slider</li> </ul>

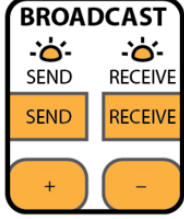

 <p><b>BROADCAST</b></p> <p>SEND RECEIVE</p> <p>SEND RECEIVE</p> <p>+ -</p>	<ul style="list-style-type: none"> <li>- Transmitter takes analog input on <b>SEND pin</b> and wirelessly transmits to receiver's <b>RECEIVE pin</b></li> <li>- Signal will trigger any receiver in vicinity, except for its own</li> </ul>
--	---

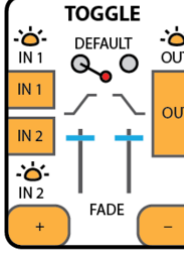
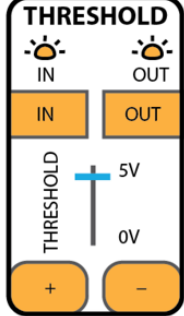
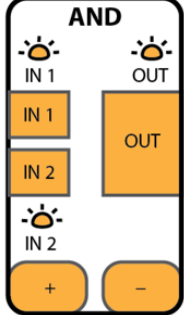
<h3>Logic &amp; Math</h3>	
 <p><b>TOGGLE</b></p> <p>IN 1 IN 2</p> <p>IN 1 IN 2</p> <p>OUT</p> <p>FADE</p> <p>+ -</p>	<ul style="list-style-type: none"> <li>- Takes analog input at <b>IN 1 pin</b> and <b>IN 2 pin</b> and waits for HIGH to LOW signal (above 4V to below 1V) at either pin to trigger state change</li> <li>- Outputs change from HIGH to LOW or LOW to HIGH outputs upon trigger, using set transition</li> <li>- User sets speed of transition (from immediate to slow fade) using two on-sticker sliders</li> <li>- User sets default state (HIGH or LOW) using on-sticker check box</li> </ul>
 <p><b>THRESHOLD</b></p> <p>IN OUT</p> <p>IN OUT</p> <p>THRESHOLD</p> <p>5V</p> <p>0V</p> <p>+ -</p>	<ul style="list-style-type: none"> <li>- Takes in analog input and listens for voltage at or above set threshold</li> <li>- Outputs HIGH signal when triggered, otherwise default LOW</li> <li>- User sets threshold with on-sticker slider</li> </ul>
 <p><b>AND</b></p> <p>IN 1 IN 2</p> <p>IN 1 IN 2</p> <p>OUT</p> <p>OUT</p> <p>+ -</p>	<ul style="list-style-type: none"> <li>- Takes two analog inputs</li> <li>- Outputs HIGH when both above 2.5V</li> </ul>

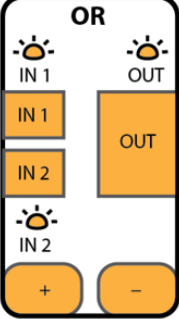
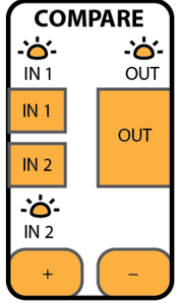
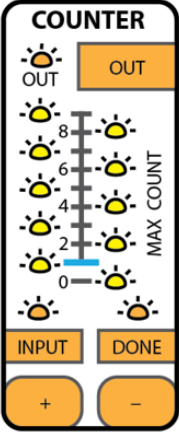
	<ul style="list-style-type: none"> <li>- Takes two analog inputs</li> <li>- Outputs HIGH when either input above 2.5V</li> </ul>
	<ul style="list-style-type: none"> <li>- Takes two analog INPUT 1 and INPUT 2</li> <li>- If INPUT 1 <math>\geq</math> INPUT 2, then outputs HIGH</li> </ul>
	<ul style="list-style-type: none"> <li>- Counts number of <b>INPUT pin</b> triggers</li> <li>- Outputs analog voltage 0v to 5v based on number counted</li> <li>- Count resets after maximum count reached</li> <li>- Outputs HIGH on <b>DONE pin</b> when maximum count reached</li> <li>- User sets maximum count on-sticker (0 to 9, for total count of 10)</li> <li>- LEDs at each number tell how many triggers counted so far</li> </ul>

Using these base units, I created an interactive dandelion example circuit (see next pages). When the circuit is powered on, yellow lights fade in and fade out for the yellow flower and white LEDs turn on for the white seed puff. When a user blows on the dandelion, the white puff blinks off and a succession of three groups of LEDs blink on and fade out to show the dispersal of seeds. Finally, a random signal triggers whether a new flower will restart.



## Dandelion Circuit: PROGRAMMING LAYER

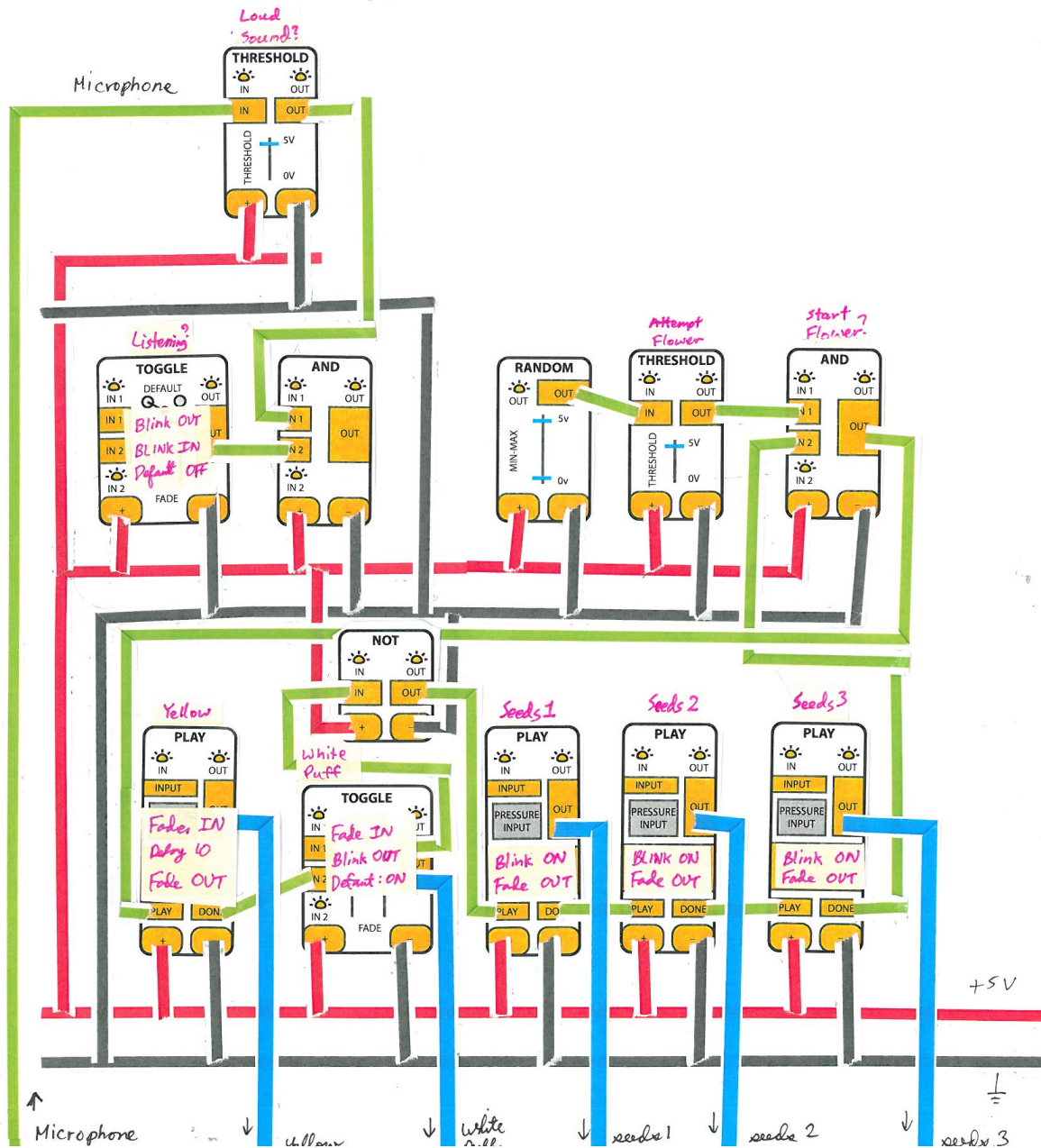

Dandelion Circuit:  
SENSING AND OUTPUT LAYER

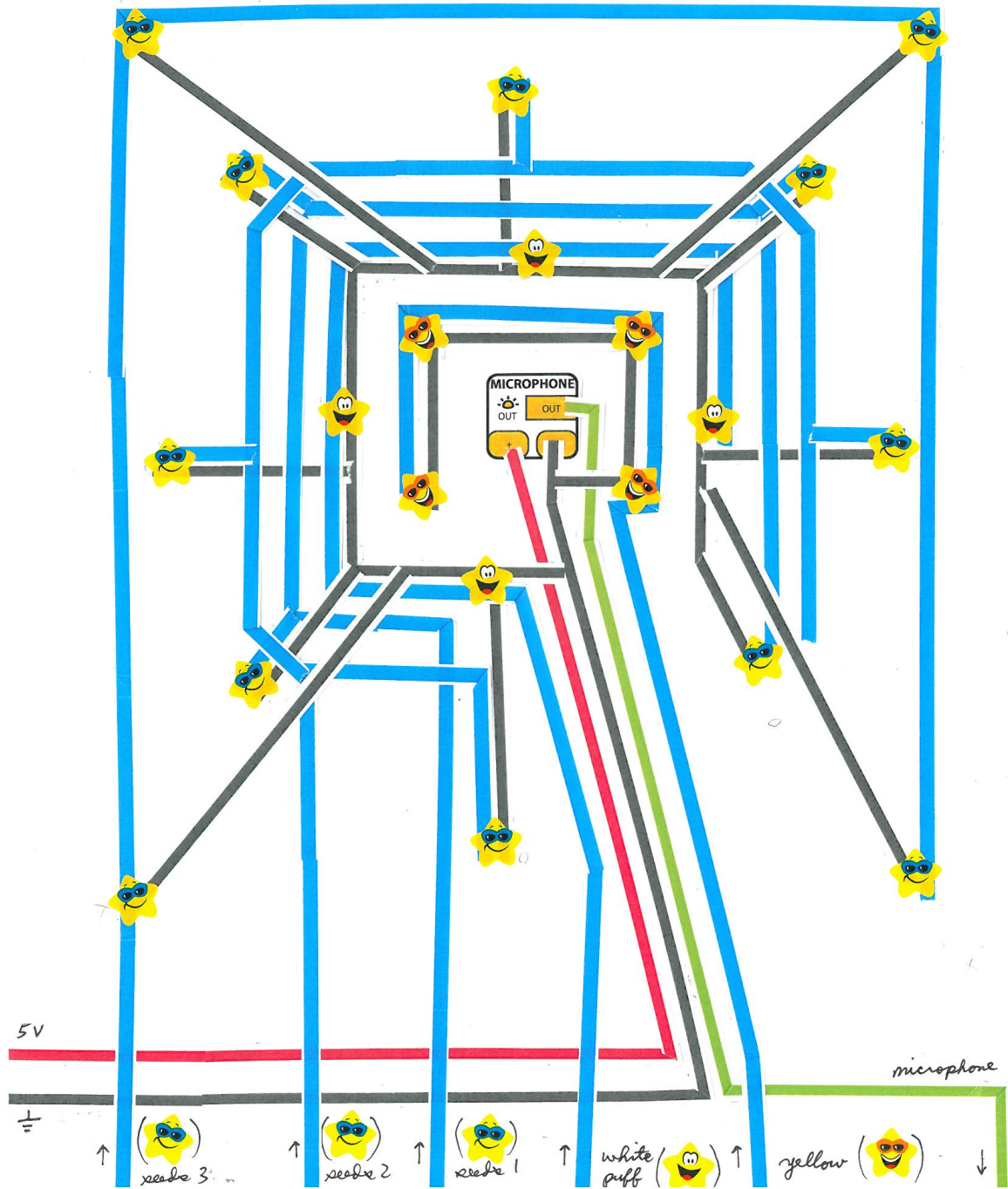

**Dandelion Circuit:  
GRAPHICAL LAYER**

